

031



**Thorax, Lung**  
**Thorax, Lunge**  
**Troácico, Pulmón**  
**Thorax, Poumon**  
**Torace, Polmone**



**Rib Shears**  
Rippenscheren  
Costótomos  
Costotomes  
Costotomi

**Sternum Chisel**  
Sternummeißel  
Cinzel para esternón  
Cisaille et ciseau-burins à sternum  
Scalpello per sterno



031



31-100-23  
23 cm, 9"

**Rib shears**  
Rippenscheren  
Costótomo  
Costotome  
Costotomo



31-102-22  
22 cm, 8¾"

**Rib shears**  
Rippenscheren  
Costótomo  
Costotome  
Costotomo



**Rib shears with drawing cut**

Rippenscheren mit ziehendem schnitt

Costótomo con hoja de retroacción

Costotome avac lame excentrée

Costotomo con lama eccentrica a scorrimento

**GLUCK**  
31-106-22  
22 cm, 8¾"

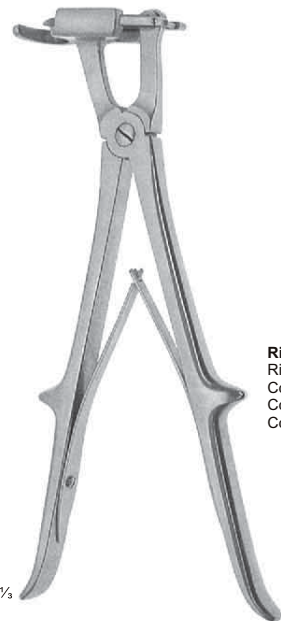

**SAUERBRUCH**  
31-110-26  
26 cm, 10¼"

**Rib shears**  
Rippenscheren  
Costótomo  
Costotome  
Costotomo

**Sternum chisel**  
Sternummeißel  
Cinzel para esternón  
Cisaille et ciseau-burins à sternum  
Scalpello per sterno



**LEBSCHKE**  
31-114-24  
24,5 cm, 9¾"



**BETHUNE**  
31-116-34  
34,5 cm, 13½"

**Rib shears**  
Rippenscheren  
Costótomo  
Costotome  
Costotomo



**Rib shears**  
 Rippenschere  
 Costótomo  
 Costotome  
 Costotomo

1/2

**STILLE-GIERTZ**  
 31-120-27  
 27 cm, 10 1/2"

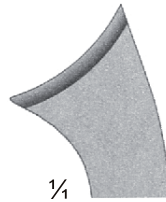

1/4

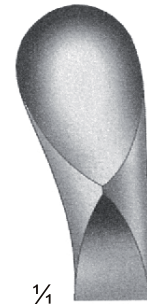

1/4



**Rib shears**  
 Rippenschere  
 Costótomo  
 Costotome  
 Costotomo

1/2

**SAUERBRUCH-FREY**  
 31-122-36  
 36 cm, 14"

**For the first rib**  
 Für die erste Rippe  
 Para la primera costilla  
 Pour la première côte  
 Per la prima costola



1/2

**MARKWALDER**  
 31-126-20  
 20 cm, 8"



1/2

**SEMB**  
 31-128-22  
 22,5cm, 9"



**Bone Cutting Forceps**  
Knochensplitterzangen  
Pinzas cortantes para huesos  
Pinces coupantes à os  
Cesoie per ossa

**Rib Rongeurs**  
Hohlmeißelzangen  
Pinzas-gubias  
Pinces-gouges  
Pinze per costole



031

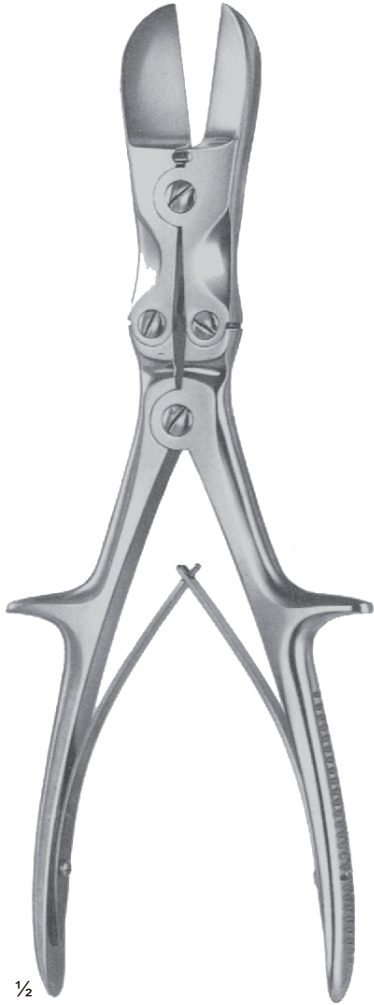

1/2

**STILLE-LISTON**  
31-130-27  
27 cm, 10 1/2"



1/2

**LISTON-KEY**  
31-132-27  
27 cm, 10 1/2"

**Bone cutting forceps, S - shaped, for posterior rib stumps**

Knochensplitterzange, doppelt gebogen, für hintere Rippenstümpfe

Pinza cortante para huesos, doble curvada, para los muñones de las costillas posteriores

Pince coupantes à os, double courbure pour extrémité des côtes postérieures

Cesoia per ossa, ad., s" per estremità delle costole posteriori

**Bone cutting forceps, curved sideways, for anterior rib stumps**

Knochensplitterzange, Seitwärts gebogen, für vordere Rippenstümpfe

Pinza cortante para huesos, curvada lateral, para los muñones de las costillas anteriores

Pince coupantes à os, courbure latérale pour extrémité des côtes antérieures

Cesoia per ossa, curve lateralmente per le estremità delle costole anteriori

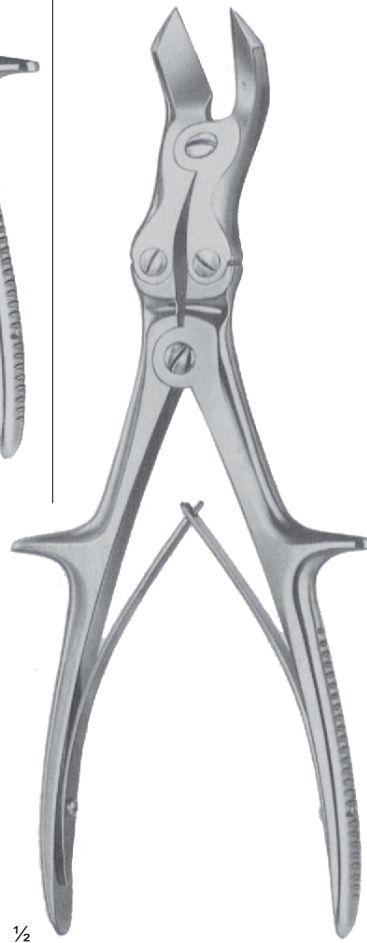

1/2

**LISTON-KEY**  
31-136-27  
27 cm, 10 1/2"



1/2

**SEMB**  
31-137-24  
24 cm, 9 1/2"



**Rib Raspatories**  
 Rippenraspatorien  
 Periostótomos costales  
 Rugines à costales  
 periostotomi costali



031

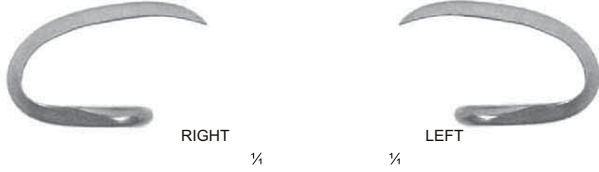

**for children**  
 Für Kinder  
 para niños  
 pour enfants  
 per bambini

**DOYEN**  
 31-144-01 ¼  
 31-144-04 ¼

31-144-01  
 17 cm, 6¾" ½

31-144-02  
 17 cm, 6¾" ½

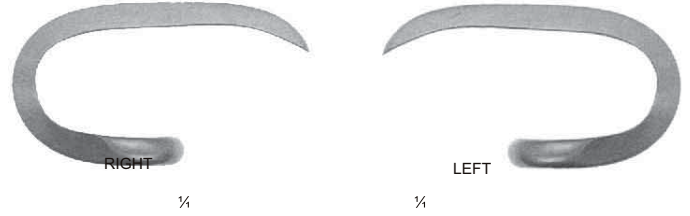

**For adults**  
 für erwachsene  
 pour adultes  
 pour adultes  
 per adulti

**DOYEN**  
 31-144-01 ¼  
 31-144-04 ¼

31-144-03  
 17 cm, 6¾" ½

31-144-04  
 17 cm, 6¾" ½



**for children**  
 Für Kinder  
 para niños  
 pour enfants  
 per bambini

**DOYEN**  
 31-140-01 ¼  
 31-140-02 ¼

31-140-01  
 15,5 cm, 6" ½

¼

31-140-02  
 15,5 cm, 6" ½



**Rib Raspatories**  
Rippenraspatorien  
Periostótomos costales  
Rugines à costales  
periostotomi costali



031

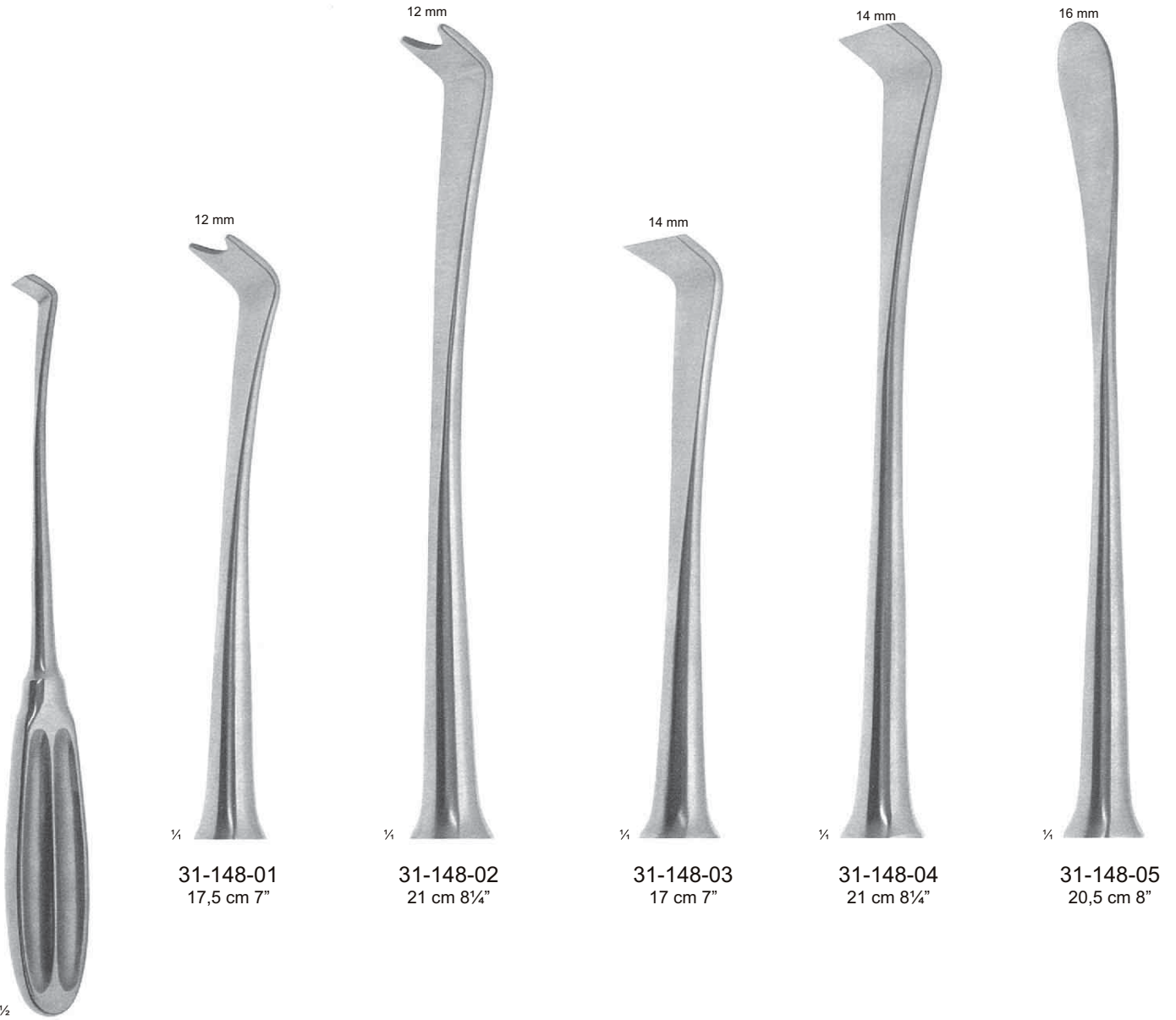

SEMB  
31-148-01  
31-148-05

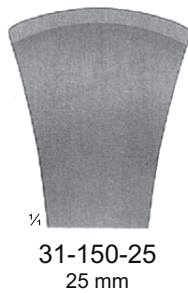
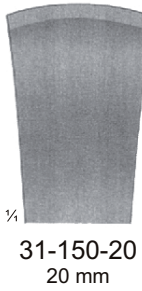
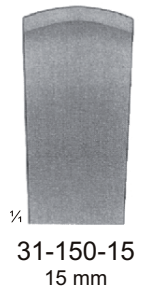
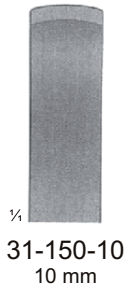

**LAMBOTTE**  
 31-150-05  
 31-150-25  
 21 cm, 8¼"

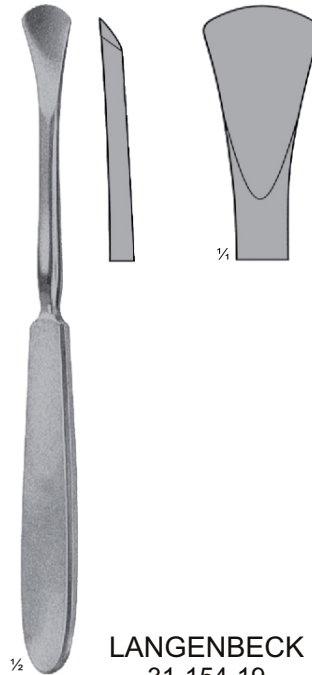

**LANGENBECK**  
 31-154-19  
 19 cm, 7½"

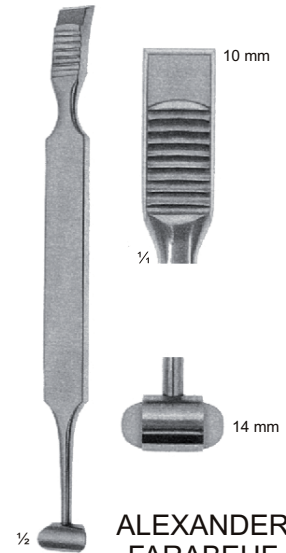

**ALEXANDER FARABEU**  
 31-158-15  
 15 cm, 6"

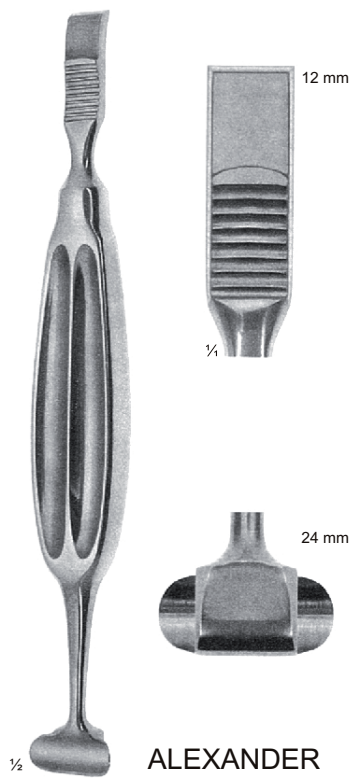

**ALEXANDER FARABEU**  
 31-164-20  
 20 cm, 8"

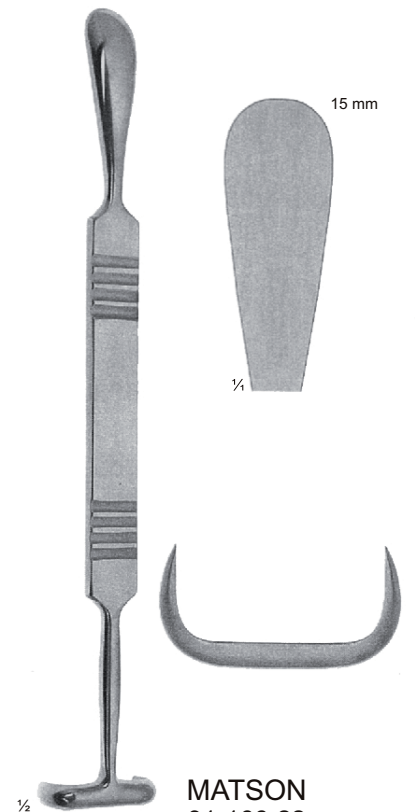

**MATSON**  
 31-166-22  
 22 cm, 8¾"

**Rib Contractors**

Rippenkonraktoren  
 Aproximadores para costillas  
 Rapprocheurs de côtes  
 Approssimatori costali

**Aortic Dilators**

Aorta-Dilatatoren  
 Dilatadores de aorta  
 Dilatateurs aortiques  
 Dilatatori per l'aorta



031



**BAILEY-BABY**  
 31-220-14  
 14 cm, 5½"



**BAILEY**  
 31-222-16  
 16 cm, 6½"



**BAILEY GIBBON**  
 31-224-16  
 16 cm, 6¼"



**SELLORS**  
 31-228-19  
 19 cm, 7½"



**COOLEY**  
 31-234-23  
 23 cm, 9"

**Left**  
 Links  
 Izquierdo  
 Gauche  
 Sinistro



**COOLEY**  
 31-236-21  
 21,5 cm, 8½"

**Right, serrated**  
 Rechts, gerieft  
 Derecho, estriado  
 Droite, cannelé  
 Destro, seghettato



**COOLEY**  
 31-238-21  
 21,5 cm, 8½"

**Rights**  
 Rechts  
 Derecho  
 Droite  
 Destro





**Blade opening from 8 - 15 mm**  
 Spreizweite 8 - 15 mm  
 Abertura de 8 a 15 mm  
 Ouverture 8 - 15 mm  
 Apertura mm 8 - 15 mm

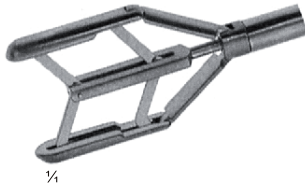

**Blade opening from 8 - 42 mm**  
 Spreizweite 8 - 42 mm  
 Abertura de 8 a 42 mm  
 Ouverture 8 - 42 mm  
 Apertura mm 8 - 42 mm

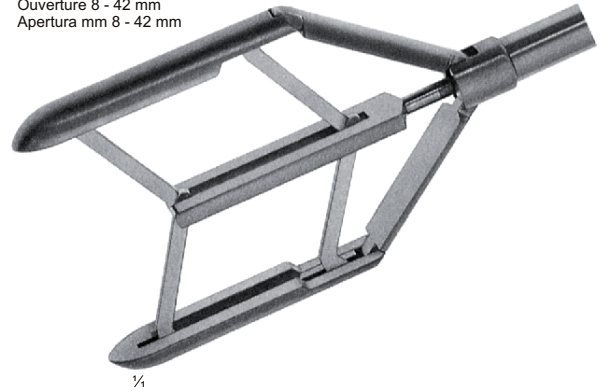

**COOLEY**  
 31-250-00

**For mitral valve (Pediatric)**  
 Für Mitralstenosen (Kinder)  
 Para estenosis mitral (Niños)  
 Pour sténoses mitrales (enfants)  
 Per stenosi mitrali (pediatrico)



**TUBBS**  
 31-252-00

**For mitral valve**  
 Für Mitralstenosen  
 Para estenosis mitral  
 Pour sténoses mitrales  
 Per stenosi mitrali



**Lung Retractors**

Lungenhaken  
Separadores para el pulmón  
Ecarteur à poumons  
Divaricatori per polmone



031

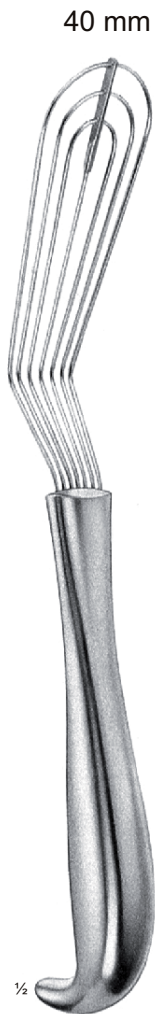

**ALLISON**  
31-254-30  
30 cm, 12"



**ALLISON**  
31-256-32  
32 cm, 12½"

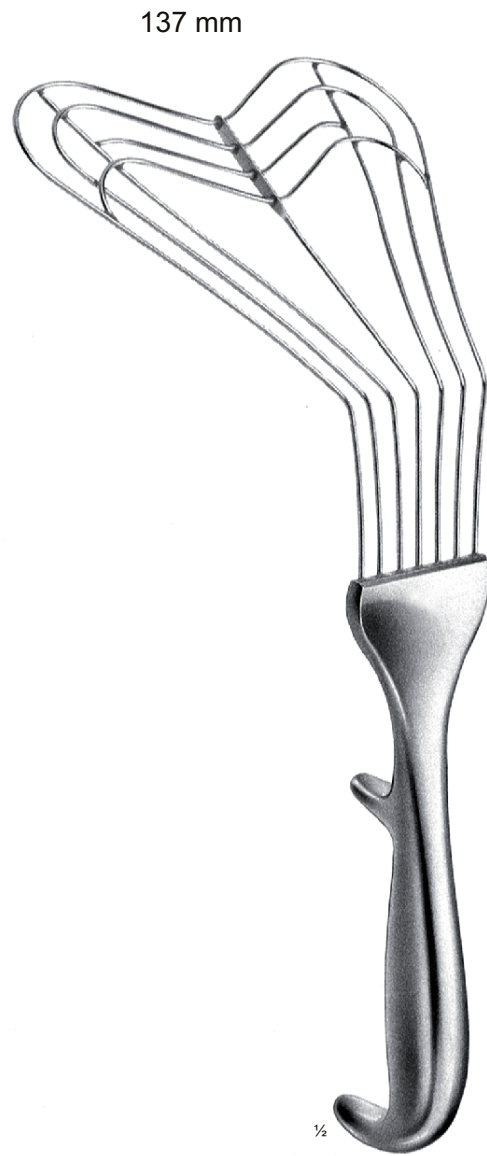

**31-258-26**  
26 cm, 10¼"

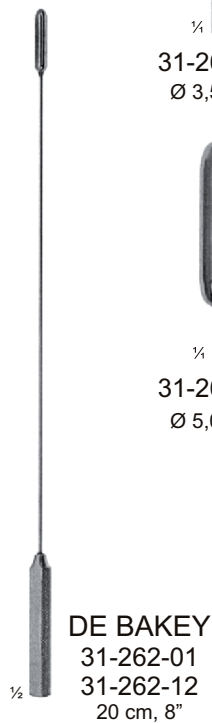
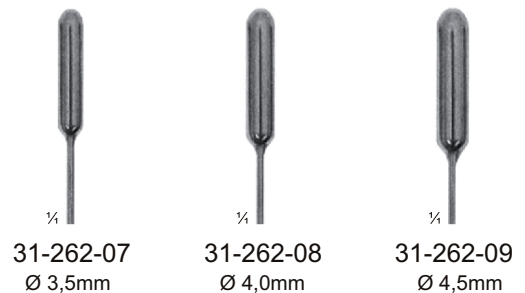
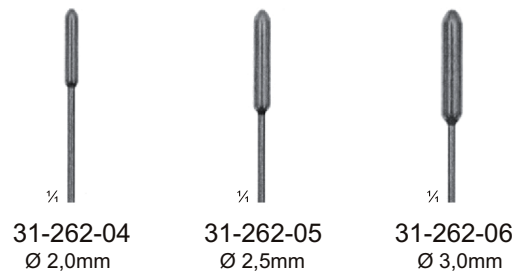
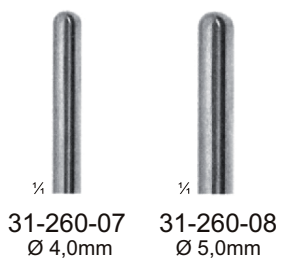
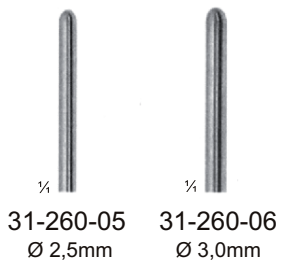
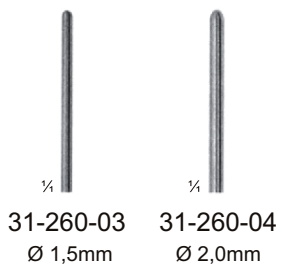
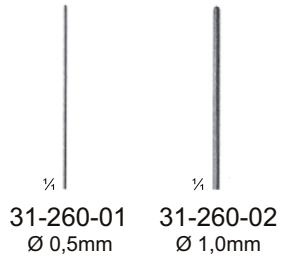



**Intima Spatulas and Dilators**  
 Intima-Spatel und -Dilatatoren  
 Espátulas y dilatadores para la íntima  
 Spatules et dilatateurs  
 Spatole e dilatatori per strutture piú interne



031

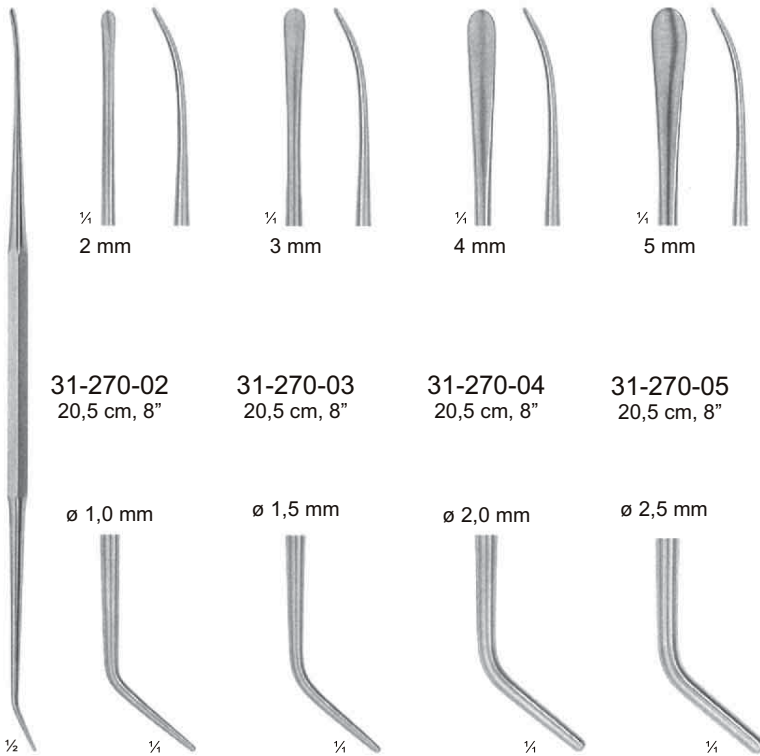

**ROBB**  
 31-270-02  
 31-270-05

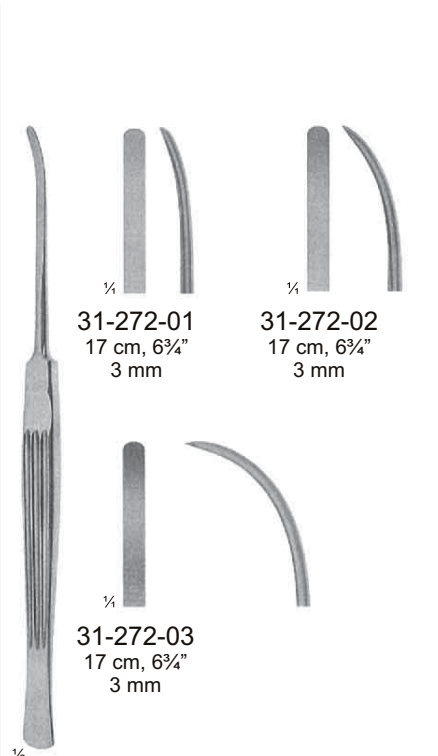

**LEMMON**  
 31-272-01  
 31-272-03

**Intima spatulas**  
 Intima-Spatel  
 Espátula para la íntima  
 Spatule pour la tunique interne  
 Spatola per intima

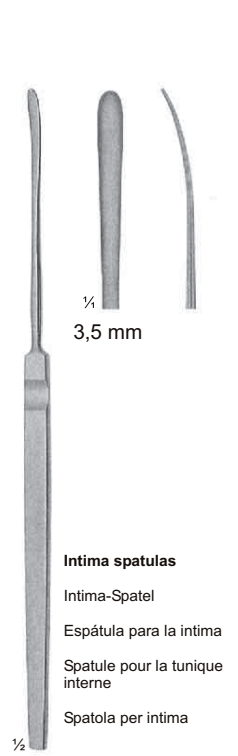

**HALLE**  
 31-274-16  
 16,5 cm, 6½"

**Intima spatulas**  
 Intima-Spatel  
 Espátula para la íntima  
 Spatule pour la tunique interne  
 Spatola per intima



**CANNON**  
 31-276-15  
 31-276-18

**Intima knife**  
 Intima-messer  
 Cuchillo para la íntima  
 Couteau pour la tunique interne  
 Bisturi per intima

**Intima spatula**  
 Intima-Spatel  
 Espátula para la íntima  
 Spatule pour la tunique interne  
 Spatola per intima

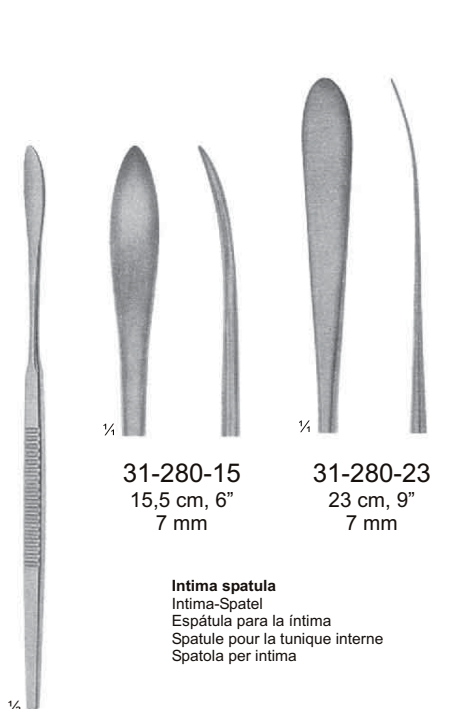

**SCHMID**  
 31-280-15  
 31-280-23

**Intima spatula**  
 Intima-Spatel  
 Espátula para la íntima  
 Spatule pour la tunique interne  
 Spatola per intima

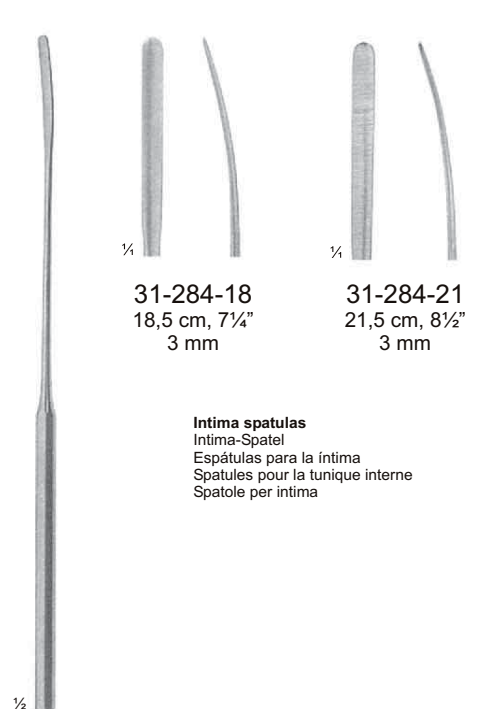

31-284-18  
 31-284-21

**Intima spatulas**  
 Intima-Spatel  
 Espátulas para la íntima  
 Spatules pour la tunique interne  
 Spatole per intima