

027



**Gynecology**  
**Gynäkologie**  
**Ginecología**  
**Gynècologie**  
**Ginecologia**



**Vaginal speculum for virgins with lateral fixation screw, tilt-down handle**

Scheidenspekulum für Jungfrauen, mit zentraler Stellschraube, Griff umlegbar

Espéculo vaginal para vírgenes, con tornillo de sujeto lateral, mango plegable

Spéculum vaginal pour vierges, avec fixation centrale à vis

Speculo vaginale per vergini, con vite di regolazione laterale



CUSCO  
27-110-01  
75 x 17 mm

**Vaginal speculum for virgins with central fixation screw, tilt-down handle**

Scheidenspekulum für Jungfrauen, mit zentraler Stellschraube, Griff umlegbar

Espéculo vaginal para vírgenes, con tornillo de sujeto central, mango plegable

Spéculum vaginal pour vierges, avec fixation centrale à vis

speculo vaginale per vergini, con vite di regolazione centrale

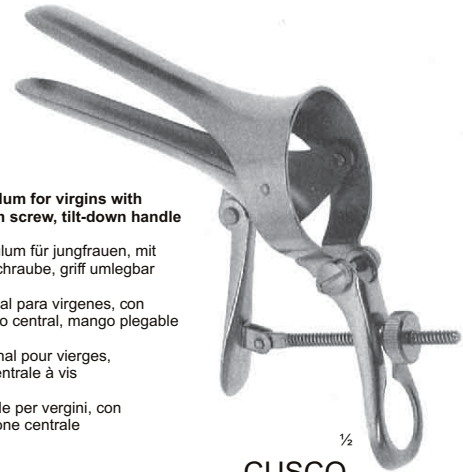

CUSCO  
27-112-01  
75 x 17 mm

**Scheme of dimensions for specula**

Maßschema für Spekula  
Esquema de dimensiones para espéculos  
Schéma de dimensions pour les spéculums  
Schema di dimensioni per specoli

**Width of blades**

Blattbreite  
Anchura de valvas  
Largeur de valves  
Larghezza delle valve

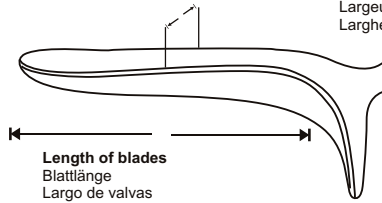

**Length of blades**

Blattlänge  
Largo de valvas  
Longueur des valves  
Lunghezza delle valve

**Vaginal specula with lateral fixation screw, tilt-down handle**

Scheidenspekula mit seitlicher Stellschraube, Griff umlegbar

Espéculos vaginales con tornillo de sujeto lateral, mango plegable

Spéculums vaginaux, avec fixation latérale à vis

Speculi vaginali, con vite di regolazione laterale



CUSCO  
27-114-01 75 x 32 mm  
27-114-02 85 x 35 mm  
27-114-03 100 x 35 mm

**Vaginal specula with central fixation screw, tilt-down handle**

Scheidenspekula mit zentraler Stellschraube, Griff umlegbar

Espéculos vaginales con tornillo de sujeto central, mango plegable

Spéculums vaginaux, avec fixation centrale à vis

Speculi vaginali, con vite di regolazione centrale

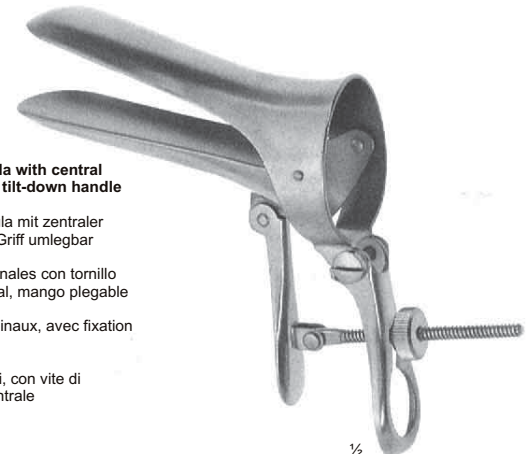

CUSCO  
27-116-01 75 x 32 mm  
27-116-02 85 x 35 mm  
27-116-03 100 x 37 mm



**Vaginal specula, Swiss pattern, cone shaped, with lateral fixation screw, tilt-down handle**

Scheidenspekula, Schweizer Modell (konisch), mit seitlicher Stellschraube, Griff umlegbar

Espéculos vaginales, modelo suizo (cónico), con tornillo de sujeto lateral, mango plegable

Spéculums vaginaux, modèle suisse (conique), avec fixation latérale à vis

Speculi vaginali, modello svizzero, profilo a cono con vite di regolazione laterale

**CUSCO**

27-120-01 90 x 22  
27-120-02 100 x 25  
27-120-03 105 x 27

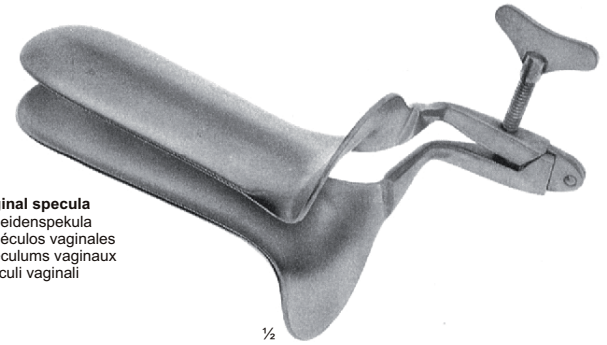

**Vaginal specula**  
Scheidenspekula  
Espéculos vaginales  
Spéculums vaginaux  
speculi vaginali

1/2

**COLLIN**

27-124-01 85 x 30mm  
27-124-02 100 x 35 mm  
27-124-03 110 x 40 mm

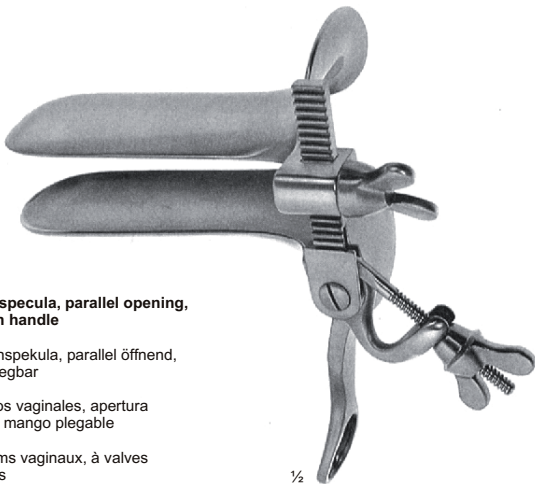

**Vaginal specula, parallel opening, tilt-down handle**

Scheidenspekula, parallel öffnend, Griff umlegbar

Espéculos vaginales, apertura paralela, mango plegable

Spéculums vaginaux, à valves parallèles

Speculi vaginali, apertura parallela

**TRELAT**

27-126-01 85 x 33 mm  
27-126-02 95 x 35 mm  
27-126-03 115 x 43 mm

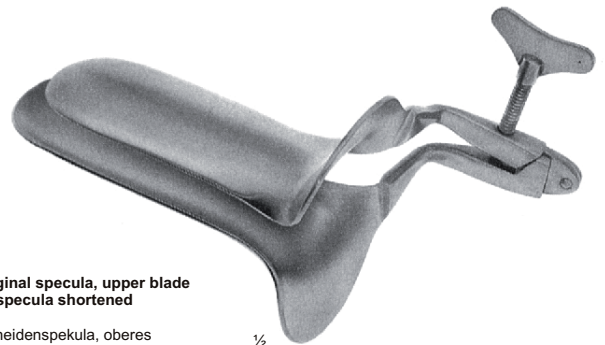

**Vaginal specula, upper blade of speculum shortened**

Scheidenspekula, oberes spekulablatt kürzer

Espéculos vaginales, valvas superior más corta

Spéculums vaginaux, valve supérieure plus courte

Speculi vaginali, valva superiore corta

1/2

**COLLIN-LANDAU**

27-128-01 85 x 30 mm  
27-128-02 100 x 35 mm  
27-128-03 110 x 40 mm



**Vaginal specula with double lock, one-hand operated**

Scheidenspekula mit doppelsperre, für einhandbedienung

Espéculos vaginales con cierre doble, para el uso con una mano

spéculums vaginaux, double ouverture utilisé à la main

Speculi vaginali, a doppio fermo, impiego con una mano

**SEMM**

- 27-136-01 90 x 14 x 18 mm  
27-136-02 100 x 17 x 20 mm  
27-136-03 100 x 25 x 30 mm

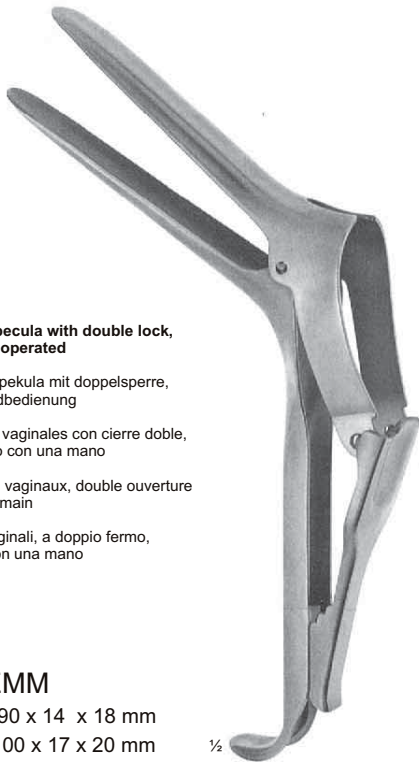

**Vaginal specula**  
Scheidenspekula  
Espéculos vaginales  
Spéculums vaginaux  
speculi vaginali

½

**GRAVE**

- 27-138-01 75 x 20 mm  
27-138-02 95 x 35 mm  
27-138-03 115 x 35 mm



**Vaginal specula**  
Scheidenspekula  
Espéculos vaginales  
Spéculums vaginaux  
speculi vaginali

**PEDERSON**

- 27-144-01 75 x 13 mm  
27-144-02 100 x 16 mm  
27-144-03 100 x 22 mm  
27-144-04 120 x 25 mm



**Vaginal speculum**  
Scheidenspekulum  
Espéculo vaginal  
Spéculum vaginal  
speculo vaginale

½

**DE VILBISS**

- 27-148-01  
102 x 32 mm

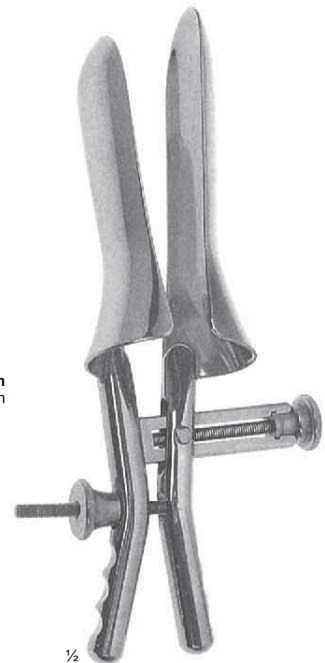



Surface black-finish  
 Oberfläche geschwärzt  
 Superficie negra  
 Surface noire  
 Superficie nera

1/2

**PEDERSON**

- 27-152-01 75 x 13 mm
- 27-152-02 100 x 22 mm
- 27-152-03 120 x 25 mm

**Vaginal specula for laser surgery, suctioning from upper blade**

Scheidenspekula für laserchirurgie, mit absaugung am oberen blatt

Espécules vaginales para la cirugía con laser, tubo de succión en la valva superior

Spéculums vaginaux pour chirurgie laser, avec embout aspiration sur la valve supérieure

Speculi vaginali per chirurgia laser, aspirazione dalla valva superiore

**PEDERSON**

- 27-154-01 75 x 13 mm
- 27-154-02 100 x 22 mm
- 27-154-03 120 x 25 mm

**Vaginal specula for laser surgery, suctioning from lower blade**

Scheidenspekula für laserchirurgie, mit absaugung am unteren blatt

Espécules vaginales para la cirugía con laser, tubo de succión en la valva inferior

Spéculums vaginaux pour chirurgie laser, avec embout aspiration sur la valve inférieure

Speculi vaginali per chirurgia laser, aspirazione dalla valva inferiore

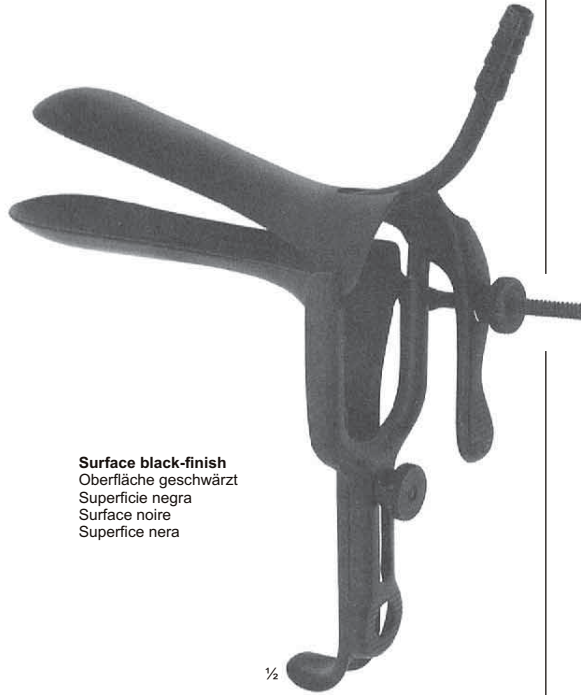

Surface black-finish  
 Oberfläche geschwärzt  
 Superficie negra  
 Surface noire  
 Superficie nera

1/2

**GRAVE**

- 27-156-01 75 x 20 mm
- 27-156-02 95 x 35 mm
- 27-156-03 115 x 35 mm

**Vaginal specula for laser surgery, suctioning from upper blade**

Scheidenspekula für laserchirurgie, mit absaugung am oberen blatt

Espécules vaginales para la cirugía con laser, tubo de succión en la valva superior

Spéculums vaginaux pour chirurgie laser, avec embout aspiration sur la valve supérieure

Speculi vaginali per chirurgia laser, aspirazione dalla valva superiore

**GRAVE**

- 27-158-01 75 x 20 mm
- 27-158-02 95 x 35 mm
- 27-158-03 115 x 35 mm

**Vaginal specula for laser surgery, suctioning from lower blade**

Scheidenspekula für laserchirurgie, mit absaugung am unteren blatt

Espécules vaginales para la cirugía con laser, tubo de succión en la valva inferior

Spéculums vaginaux pour chirurgie laser, avec embout aspiration sur la valve inférieure

Speculi vaginali per chirurgia laser, aspirazione dalla valva inferiore



1/3

**KOGAN**  
 27-166-24  
 24 cm 9 1/2"

**Endospecula for cervix and urethra**  
 Endospekula für Harnröhre und cervix  
 Endoespécules para cerviz y uretra  
 Speculums pour urètre et col utérin  
 Endospeculi per cervice ed uretra

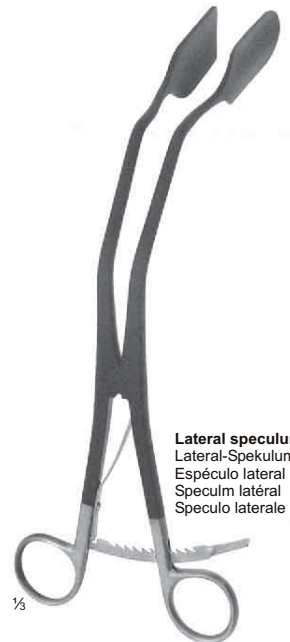

1/3

**Lateral speculum**  
 Lateral-Spekulum  
 Espécúlo lateral  
 Speculum latéral  
 Speculo laterale

27-168-25  
 25 cm 10"

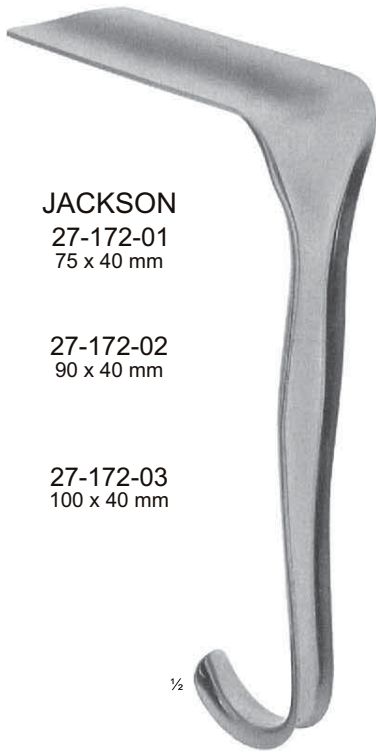

**JACKSON**  
 27-172-01  
 75 x 40 mm

27-172-02  
 90 x 40 mm

27-172-03  
 100 x 40 mm

½

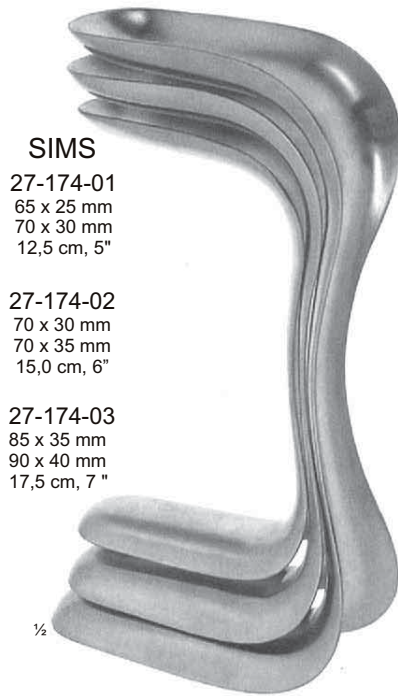

**SIMS**  
 27-174-01  
 65 x 25 mm  
 70 x 30 mm  
 12,5 cm, 5"

27-174-02  
 70 x 30 mm  
 70 x 35 mm  
 15,0 cm, 6"

27-174-03  
 85 x 35 mm  
 90 x 40 mm  
 17,5 cm, 7"

½

**Vaginal specula, double-ended**  
 Scheidenspekula, doppelending  
 Espéculos vaginales, dobles  
 Spéculums vaginaux, doubles  
 Speculi vaginali, doppi

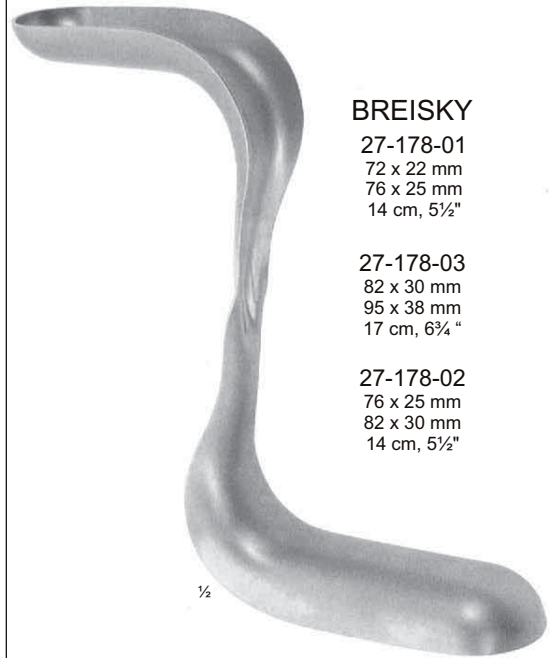

**BREISKY**  
 27-178-01  
 72 x 22 mm  
 76 x 25 mm  
 14 cm, 5½"

27-178-03  
 82 x 30 mm  
 95 x 38 mm  
 17 cm, 6¾"

27-178-02  
 76 x 25 mm  
 82 x 30 mm  
 14 cm, 5½"

½

**Vaginal specula, double-ended**  
 Scheidenspekula, doppelending  
 Espéculos vaginales, dobles  
 Spéculums vaginaux, doubles  
 Speculi vaginali, doppi



**KRISTELLER**

27-180-01  
 115 x 23 mm

27-180-02  
 115 x 26 mm

27-180-03  
 115 x 32 mm

½

**Set of 1 speculum and 1 retractor each**  
 Satz aus je 1 Spekulum und 1 halter  
 Juego de 1 espéculo y 1 valva  
 Jeu de 1 spéculum et 1 vlave  
 Set speculo e valva



**KRISTELLER**

27-182-01  
 70 x 27 mm

27-182-02  
 80 x 30 mm

27-182-03  
 90 x 36 mm

½

**Specula only**  
 Spekula allein  
 Espéculos sueltos  
 Spéculums seuls  
 Solo speculi



**KRISTELLER**

27-184-01  
 75 x 23 mm

27-184-02  
 85 x 26 mm

27-184-03  
 100 x 32 mm

½

**Retractors only**  
 Halter allein  
 Valvas sueltas  
 Valves seules  
 Solo valve



### Vaginal Specula and Retractors

Scheidenspekula und-halter  
Especulos y valvas vaginales  
Spéculums et valves vaginaux  
Speculi e valve vaginali



027

**Set of 1 speculum and 1 retractor each**  
Satz aus je 1 Spekulum und 1 halter  
Juego de 1 espéculo y 1 valva  
Jeu de 1 spéculum et 1 vlave  
Set speculo e valva



**KRISTELLER**  
27-190-01  
27-190-02

½

**Specula only**  
Spekula allein  
Especulos sueltos  
Spéculums seuls  
Solo speculi

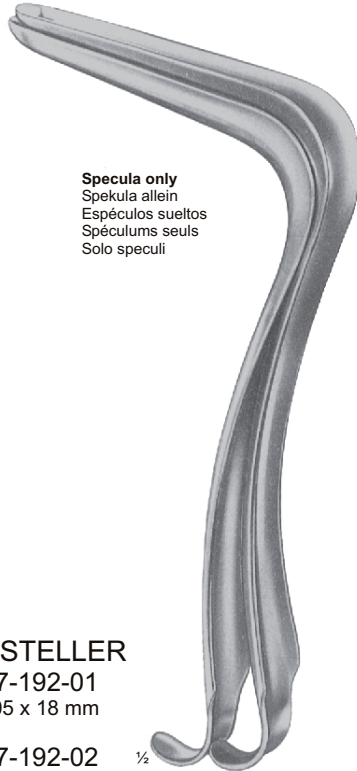

**KRISTELLER**  
27-192-01  
105 x 18 mm

27-192-02  
105 x 21 mm

½

**Retractors only**  
Halter allein  
Valvas sueltas  
Valves seules  
Solo valve



**KRISTELLER**  
27-194-01  
110 x 14 mm

27-194-02  
110 x 17 mm

½

**Set of 1 speculum and 1 retractor each**  
Satz aus je 1 Spekulum und 1 halter  
Juego de 1 espéculo y 1 valva  
Jeu de 1 spéculum et 1 vlave  
Set speculo e valva



**KRISTELLER**  
27-200-01  
27-200-02  
27-200-03

½

**Specula only**  
Spekula allein  
Especulos sueltos  
Spéculums seuls  
Solo speculi



**KRISTELLER**  
27-202-01  
105 x 26 mm

27-202-02  
105 x 28 mm

27-202-03  
105 x 33 mm

½

**Retractors only**  
Halter allein  
Valvas sueltas  
Valves seules  
Solo valve



**KRISTELLER**  
27-204-01  
115 x 22 mm

27-204-02  
115 x 24 mm

27-204-03  
115 x 29 mm

½

### Vaginal Specula and Retractors

Scheidenspekula und-halter  
 Espéculos y valvas vaginales  
 Spéculums et valves vaginaux  
 Speculi e valve vaginali



Set of 1 speculum and 1 retractor each  
 Satz aus je 1 Spekulum und 1 halter  
 Juego de 1 espéculo y 1 valva  
 Jeu de 1 spéculum et 1 vlave  
 Set speculo e valva

**KRISTELLER**  
 27-210-01  
 27-210-02  
 27-210-03



Specula only  
 Spekula allein  
 Espéculos sueltos  
 Spéculums seuls  
 Solo speculi

**KRISTELLER**  
 27-212-01  
 110 x 27 mm  
 27-212-02  
 110 x 30 mm  
 27-212-03  
 110 x 36 mm



Retractors only  
 Halter allein  
 Valvas sueltas  
 Valves seules  
 Solo valve

**KRISTELLER**  
 27-214-01  
 115 x 23 mm  
 27-214-02  
 115 x 26 mm  
 27-254-03  
 115 x 32 mm

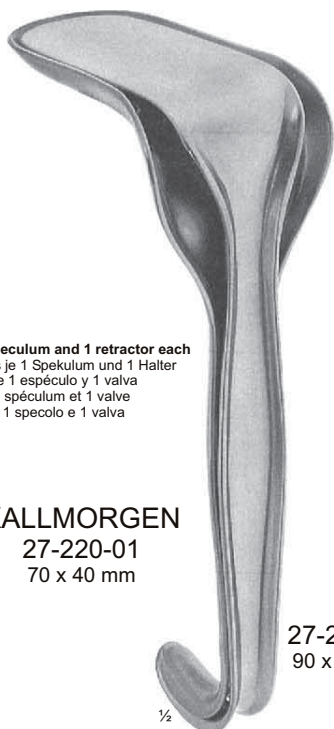

Set 1 speculum and 1 retractor each  
 Satz aus je 1 Spekulum und 1 Halter  
 Juego de 1 espéculo y 1 valva  
 Jeu de 1 spéculum et 1 valva  
 Serie da 1 specolo e 1 valva

**KALLMORGEN**  
 27-220-01  
 70 x 40 mm

27-221-02  
 90 x 40 mm

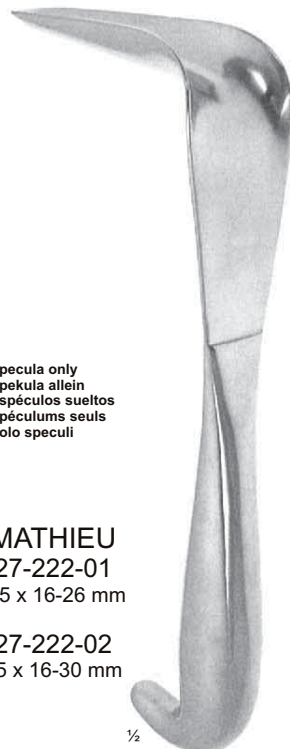

Specula only  
 Spekula allein  
 Espéculos sueltos  
 Spéculums seuls  
 Solo speculi

**MATHIEU**  
 27-222-01  
 95 x 16-26 mm  
 27-222-02  
 95 x 16-30 mm

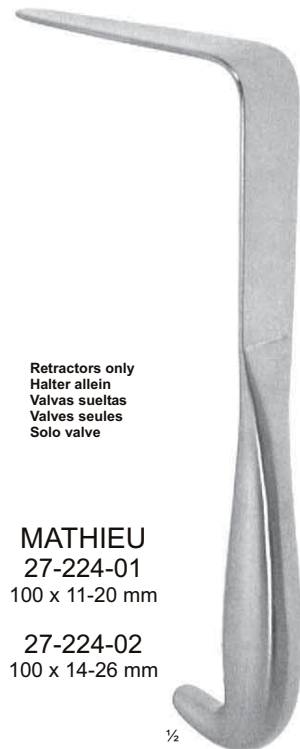

Retractors only  
 Halter allein  
 Valvas sueltas  
 Valves seules  
 Solo valve

**MATHIEU**  
 27-224-01  
 100 x 11-20 mm  
 27-224-02  
 100 x 14-26 mm



**Vaginal Specula and Retractors**

Scheidenspekula und-halter  
 Espéculos y valvas vaginales  
 Spéculums et valves vaginaux  
 Speculi e valve vaginali

**Abdominal Retractors**

Bauchdeckenhalter  
 Separadores abdominales  
 Ecarteurs abdominaux  
 Divaricatori addominali

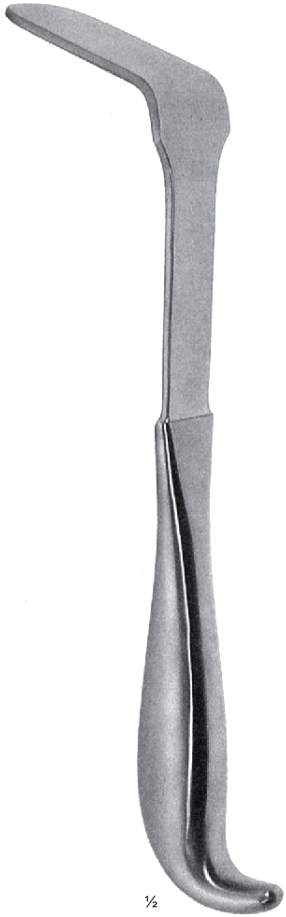

½

**DOYEN**

- 27-226-01 60 x 30 mm
- 27-226-02 70 x 30 mm
- 27-226-03 80 x 30 mm
- 25 cm, 10"

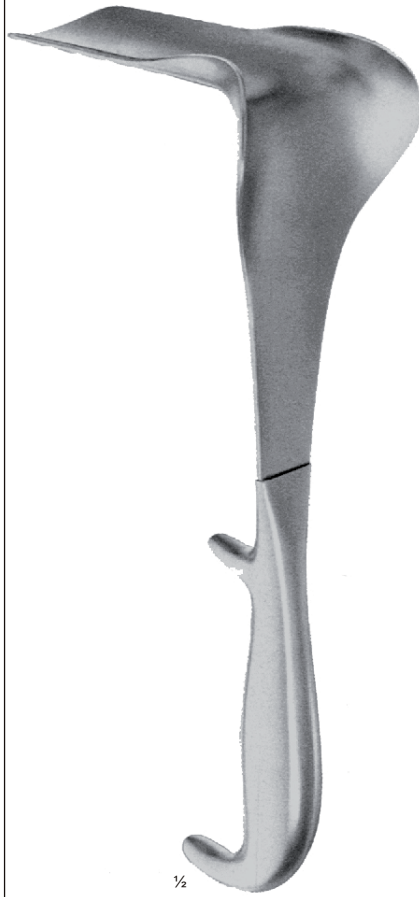

½

**DOYEN**

24 cm, 9½"



½

**DOYEN**

24 cm, 9½"

	Fig	A	B	
27-228-01	1	55mm	35mm	27-232-01
27-228-02	2	85mm	35mm	27-232-02
27-228-03	3	115mm	35mm	27-232-03
27-229-01	1	55mm	60mm	27-233-01
27-229-02	2	85mm	60mm	27-233-02
27-229-03	3	115mm	60mm	27-233-03
27-229-04	4	160mm	60mm	27-233-04
27-229-05	5	180mm	60mm	27-233-05
27-230-01	1	55mm	60mm	27-234-01
27-230-02	2	85mm	60mm	27-234-02
27-230-03	3	115mm	60mm	27-234-03
27-230-04	4	160mm	60mm	27-234-04
27-230-05	5	180mm	60mm	27-234-05



½

**LANDAU**

- 27-244-01 100 x 28 mm
- 27-244-02 105 x 38 mm



½

**BREISKY**

- 27-246-01 100 x 15 mm
- 27-246-02 100 x 20 mm
- 27-246-03 100 x 25 mm
- 27-246-04 100 x 30 mm
- 27-246-05 100 x 35 mm
- 27-246-06 100 x 40 mm
- 27-246-07 130 x 15 mm
- 27-246-08 130 x 20 mm
- 27-246-09 130 x 25 mm
- 27-246-10 130 x 30 mm
- 27-246-11 130 x 35 mm
- 27-246-12 130 x 40 mm
- 27-246-13 155 x 40 mm
- 27-246-14 180 x 40 mm



½

**MATZENAUER**

- 27-248-01 125 x 15 mm
- 27-248-02 125 x 20 mm
- 27-248-03 125 x 25 mm
- 27-248-04 125 x 30 mm
- 27-248-05 125 x 35 mm
- 27-248-06 125 x 40 mm



**AUVARD**

27-252-01 70 x 38 mm

27-252-02 80 x 38 mm

27-252-03 102 x 38 mm

**Vaginal specula with fixed weight**  
 Scheidenspekula mit festem gewicht  
 Espéculos vaginal con peso fijo  
 Spéculums vaginal avec poids fixe  
 Speculi vaginalii con peso fisso



**AUVARD-BERLIND**

27-254-00 70 x 38 mm

27-254-01 80 x 38 mm

27-254-02 102 x 38 mm

**Vaginal speculum with fixed weight and holes in blade**  
 Scheidenspekulum mit festem Gewicht und löchern im blatt  
 Espéculo vaginal con peso fijo y valva perforada  
 Spéculum vaginal avec poids fixe et valve à trous  
 Speclo vaginale con peso fisso e fori sulla lama



**AUVARD**

27-256-00 80 x 38 mm

27-256-01 102 x 45 mm

**Vaginal speculum with detachable weight**  
 Scheidenspekulum mit abnehmbarem gewicht  
 Espéculo vaginal con peso desmontable  
 Spéculum vaginal avec poids démontable  
 Speculo vaginale a peso smontabile

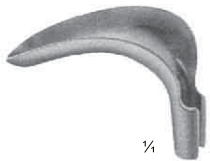

27-260-11  
80 x 30 mm

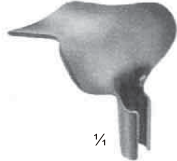

27-260-14  
55 x 40-60mm



27-260-12  
85 x 35 mm

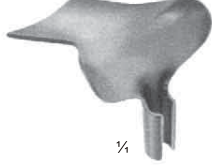

27-260-15  
70 x 45-70 mm

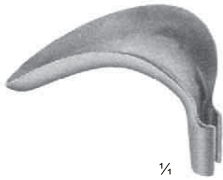

27-260-13  
90 x 40 mm

**Set, consisting of:**  
27-260-01 1 Handle  
27-260-03 1 Weight 0,4 kg  
27-260-11 1 Blade 80 x 30 mm  
27-260-12 1 Blade 85 x 35 mm  
27-260-13 1 Blade 90 x 40 mm  
27-260-14 1 Blade 55 x 40-60 mm  
27-260-15 1 Blade 70 x 45-70 mm

**Juego, compuesto de:**  
27-260-01 1 Mango  
27-260-03 1 Peso 0,4 kg  
27-260-11 1 Valva 80 x 30 mm  
27-260-12 1 Valva 85 x 35 mm  
27-260-13 1 Valva 90 x 40 mm  
27-260-14 1 Valva 55 x 40-60 mm  
27-260-15 1 Valva 70 x 45-70 mm

**Serie, composta da:**  
27-260-01 1 Manico  
27-260-03 1 Peso 0,4 kg  
27-260-11 1 Valva 80 x 30 mm  
27-260-12 1 Valva 85 x 35 mm  
27-260-13 1 Valva 90 x 40 mm  
27-260-14 1 Valva 55 x 40-60 mm  
27-260-15 1 Valva 70 x 45-70 mm

**Satz, bestehend aus:**  
27-260-01 1 Griff  
27-260-03 1 Gewicht 0,4 kg  
27-260-11 1 Blatt 80 x 30 mm  
27-260-12 1 Blatt 85 x 35 mm  
27-260-13 1 Blatt 90 x 40 mm  
27-260-14 1 Blatt 55 x 40-60 mm  
27-260-15 1 Blatt 70 x 45-70 mm

**Jeu, composé de:**  
27-260-01 1 Manche  
27-260-03 1 Poids 0,4 kg  
27-260-11 1 Valve 80 x 30 mm  
27-260-12 1 Valve 85 x 35 mm  
27-260-13 1 Valve 90 x 40 mm  
27-260-14 1 Valve 55 x 40-60 mm  
27-260-15 1 Valve 70 x 45-70 mm

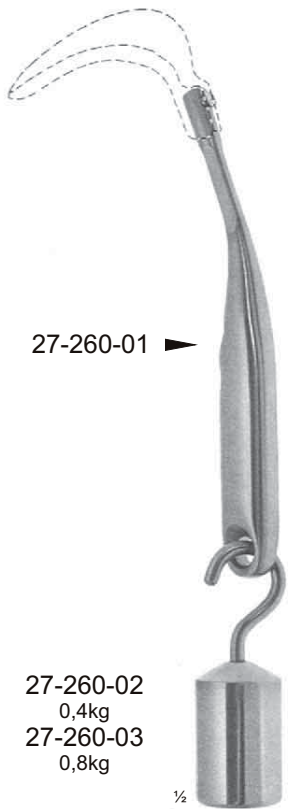

27-260-01

27-260-02  
0,4kg  
27-260-03  
0,8kg

**SCHERBAK**  
27-260-00

Set, Satz, Juego, Jeu, Serie



80 x 42 mm

**WEISSBARTH**  
27-264-00  
80 x 42 mm

**Vaginal speculum with removable strainer and perforated bottom**

Scheidenspekulum mit abnehmbarem auffangsieb

Espéculo vaginal con tamiz desmontable

Spéculum vaginal avec tamis démontable

Speculo vaginale con filtro smontabile et fondo forato

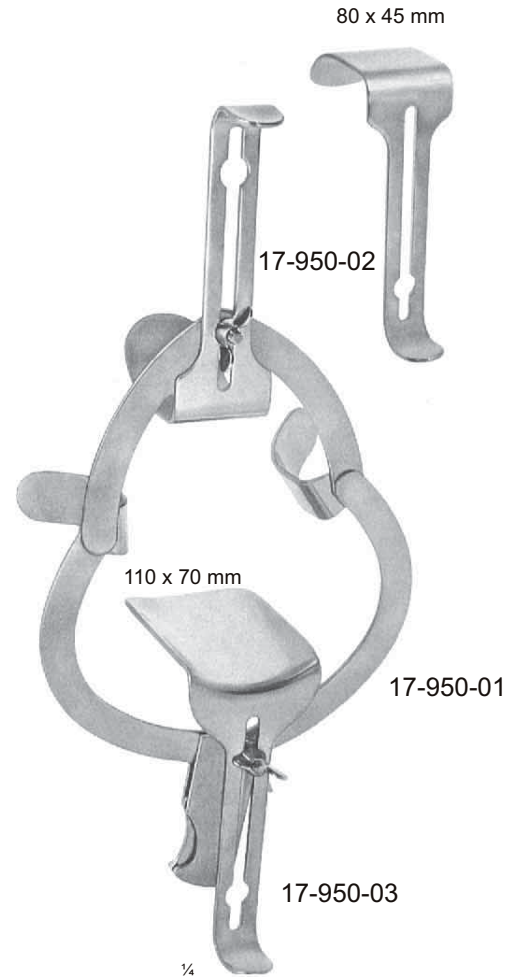

80 x 45 mm

17-950-02

110 x 70 mm

17-950-01

17-950-03

**O'SULLIVAN-O'CONNOR**  
17-920-00

Set, Satz, Juego, Jeu, Serie

**Abdominal retractor, complete, consisting of:**  
17-920-01 1 Frame with 2 lateral valves 62 x 25 mm  
17-920-02 2 Valves 81 x 46 mm  
17-920-03 1 Valve 110 x 72 mm

Bauchdeckenhalter, komplett, bestehend aus:  
17-920-01 1 Rahmen mit 2 Seitenvalven 62 x 25 mm  
17-920-02 2 Valven 81 x 46 mm  
17-920-03 1 Valve 110 x 72 mm

Separador abdominal, completo, compuesto de:  
17-920-01 1 Cuadro con 2 valvas laterales 62 x 25 mm  
17-920-02 2 Valvas 81 x 46 mm  
17-920-03 1 Valva 110 x 72 mm

Ecarteur abdominal, complet, composé de:  
17-920-01 1 Cadre avec 2 valves latérales 62 x 25 mm  
17-920-02 2 Valves 82 x 46 mm  
17-920-03 1 Valve 110 x 72 mm

Divaricatore addominale, completo, compsto da:  
17-920-01 1 Telaio con valve laterali 62 x 25 mm  
17-920-02 2 Valve 81 x 46 mm  
17-920-03 1 Valva 110 x 72 mm



**KOGAN**  
27-270-24  
24 cm, 9½"

**Endospeculum for cervix and urethra, without catch**

Endospekulum für Harnröhre und Cervix, ohne Sperre

Endospecúlo para uretra y cerviz, sin cierre

Endospéculum pour urètre et col utérin, sans verrou

Endospeculi per cervice e uretra, senza cremagliera



**KOGAN**  
27-272-24  
24 cm, 9½"

**Endospeculum for cervix and urethra, with scale-ratchet and fixing screws**

Endospekulum für Harnröhre und Cervix, mit Skaiensperre und Fixierschraube

Endospecúlo para uretra y cerviz, con cierre graduado y tomillo fijador

Endospéculum pour urètre et col utérin crémaillère à vis

Endospeculo per cervice e uretra, con nottolino graduato a vite di fissaggio



**KOGAN**  
27-274-24  
24 cm, 9½"

**Endospeculum for cervix and urethra, with catch**

Endospekula für Harnröhre und Cervix, mit Sperre

Endospecúlos para uretra y cerviz, con cierre

Endospéculum pour urétra et col utérin, avec crémaillère avec verrou

Endospeculi per cervice e uretra, con cremagliera



**GOODELL**  
27-276-34  
34 cm, 13½"

**Uterine dilator**  
Uterus-Dilatator  
Dilatador uterino  
Dilatateur du col de l'utérus  
Dilatatore uterino



½

**SIMS**  
 27-280-32  
 32 cm, 12½"

Graduated in inch, malleable, silver-plated

mit Zolleinteilung, biegsam versilbert

Graduado en pulgadas, maleable, plateado

Gradué en pouces, malléable, argent

Graduato in pollici, malleabile, placcato in argento



½

**SIMS**  
 27-282-32  
 32 cm, 12½"

Graduated in centimeters, malleable, silver-plated

mit Zolleinteilung, biegsam versilbert

Graduado en centímetros, maleable, plateado

Gradué en cm, malléable, argent

Graduato in cm, malleabile, placcato in argento



½

**SIMS**  
 27-286-32  
 32 cm, 12½"

Graduated in centimeters, malleable, 18/8 steel

mit Zolleinteilung, biegsam 18/8 Stahl

Graduado en centímetros, maleable, acero 18/8

Gradué en cm, malléable, acier inox

Graduato in cm, malleabile, acciaio inox 18/8



½

**SIMPSON**  
 27-288-34  
 34 cm, 13½"

Graduated in centimeters, malleable, silver-plated

Mit Zentimetereinteilung, biegsam, versilbert

Graduado en centímetros, maleable, plateado

graduado en cm, malleable, argent

Graduto in cm, malleabile, placcato in argento



½

**VALLEIX**  
 27-294-25  
 25 cm, 10"

Graduated in centimeters, with slider, malleable, Chromium plated

mit Zolleinteilung, und schieber, biegsam, verchromt

Graduado en centímetros, con un cursor, maleable, cromado

Gradué en cm avec curseur, malléable, chromé

Graduato in cm, com cursore, malleabile, cromato



½

**BRAUN**  
 27-300-28  
 28 cm, 11"

**Uterine depressor**  
 Uterus-Depressor  
 Depresor uterino  
 Dépresseur utérin  
 Depressori uterini

**Uterine gauze packer**  
 Tamponadeführer  
 Conductor de tampones  
 Conducteur porte-tampon  
 Porta garzaa uterino



½

**SIMS**  
 27-304-26  
 26 cm, 10¼"

**Uterine depressor**  
 Uterus-Depressor  
 Depresor uterino  
 Dépresseur utérin  
 Depressori uterini

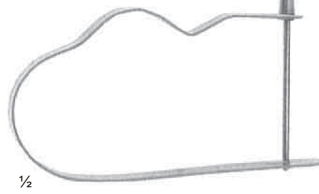

½

27-306-01 3 mm x 220 mm  
 27-306-02 3 mm x 285 mm

**IUD (intra Uterine Device)- Forceps with flexible shaft**  
 IUP (Intrauterinpessar)- Faßzangen mit flexiblem Schaft  
 Pinzas DIU (Dispositivo Intra-Uterino) con vástago flexible  
 Pince-DIU tige flexible  
 Pinza intra-uterina con asta flessibile



½

**AMANN**  
 27-310-32  
 32 cm, 12½"

**Uterine gauze packer**  
 Tamponadeführer  
 Conductor de tapones  
 Conducteur porte-tampon  
 Porta garza uterino



½

**HEGAR**

- 27-322-01 Ø 1,0 mm
  - 27-322-02 Ø 2,0 mm
  - 27-322-03 Ø 3,0 mm
  - 27-322-04 Ø 4,0 mm
  - 27-322-05 Ø 5,0 mm
  - 27-322-06 Ø 6,0 mm
  - 27-322-07 Ø 7,0 mm
  - 27-322-08 Ø 8,0 mm
  - 27-322-09 Ø 9,0 mm
  - 27-322-10 Ø 10,0 mm
  - 27-322-11 Ø 11,0 mm
  - 27-322-12 Ø 12,0 mm
  - 27-322-13 Ø 13,0 mm
  - 27-322-14 Ø 14,0 mm
  - 27-322-15 Ø 15,0 mm
  - 27-322-16 Ø 16,0 mm
  - 27-322-17 Ø 17,0 mm
  - 27-322-18 Ø 18,0 mm
  - 27-322-19 Ø 19,0 mm
  - 27-322-20 Ø 20,0 mm
  - 27-322-21 Ø 21,0 mm
  - 27-322-22 Ø 22,0 mm
  - 27-322-23 Ø 23,0 mm
  - 27-322-24 Ø 24,0 mm
  - 27-322-25 Ø 25,0 mm
  - 27-322-26 Ø 26,0 mm
- 18,5 cm, 7¼"

**With sloped handle**  
 Mit glattem Muldenriff  
 con mango aplanado  
 á manche aplati  
 con manico inclinato



½

**HEGAR**

- 27-323-01 Ø 1,5 mm
  - 27-323-02 Ø 2,5 mm
  - 27-323-03 Ø 3,5 mm
  - 27-323-04 Ø 4,5 mm
  - 27-323-05 Ø 5,5 mm
  - 27-323-06 Ø 6,5 mm
  - 27-323-07 Ø 7,5 mm
  - 27-323-08 Ø 8,5 mm
  - 27-323-09 Ø 9,5 mm
  - 27-323-10 Ø 10,5 mm
  - 27-323-11 Ø 11,5 mm
  - 27-323-12 Ø 12,5 mm
  - 27-323-13 Ø 13,5 mm
  - 27-323-14 Ø 14,5 mm
  - 27-323-15 Ø 15,5 mm
  - 27-323-16 Ø 16,5 mm
  - 27-323-17 Ø 17,5 mm
- 18,5 cm, 7¼"

**With sloped handle**  
 Mit glattem Muldenriff  
 con mango aplanado  
 á manche aplati  
 con manico inclinato

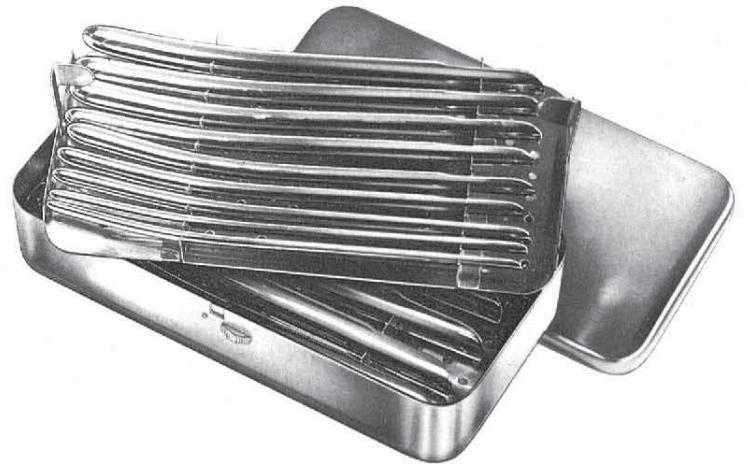

**HEGAR**  
 27-330-00



**HEGAR**  
 27-330-01

Set in metal case  
 Satz in Metalltui  
 Juego en estuche de metal  
 jeu en boîte métallique  
 Serie in scatola metallica

Pieces per set	set	
Stück per Satz	Satz	
Piezas por juego	juego	
Pièces par jeu	jeu	
Pezzi per serie	serie	

14	4,0-17,0 mm	27-330-00
26	1,0-26,0 mm	27-330-01





1/2

23-336-02

**HEGAR**

- 27-336-02 Ø 1/2 mm
- 27-336-03 Ø 2/3 mm
- 27-336-04 Ø 3/4 mm
- 27-336-06 Ø 5/6 mm
- 27-336-08 Ø 7/8 mm
- 27-336-10 Ø 9/10 mm
- 27-336-12 Ø 11/12 mm
- 27-336-14 Ø 13/14 mm
- 27-336-16 Ø 15/16 mm
- 27-336-18 Ø 17/18 mm
- 27-336-20 Ø 19/20 mm
- 27-336-22 Ø 21/22 mm
- 27-336-24 Ø 23/24 mm
- 27-336-26 Ø 25/26 mm

20 cm, 8"



**HEGAR**  
 27-338-00

Dilator set, consisting of:  
 27-336-04\_27-336-18 8 Dilators Ø 3/4-17/18 mm  
 27-338-01 1 Boilable canvas roll

Dilatatoren-Satz, bestehend aus:  
 27-336-04\_27-336-18 8 Dilatatoren Ø 3/4-17/18 mm  
 27-338-01 1 auskochbare Segeltuchrolle

Juego de dilataores, compuesto de:  
 27-336-04\_27-336-18 8 Dilataores de Ø 3/4-17/18 mm  
 27-338-01 1 Bolsa de tela esterilizable por ebullición

Jeu de dilataeurs, composé de:  
 27-336-04\_27-336-18 8 Dilataeurs de Ø 3/4-17/18 mm  
 27-338-01 1 Trousse stérilisable par ébullition

Set dilatatori, composto da:  
 27-336-04\_27-336-18 8 Dilatatori Ø 3/4-17/18 mm  
 27-338-01 1 Borsa telata sterilizzabile

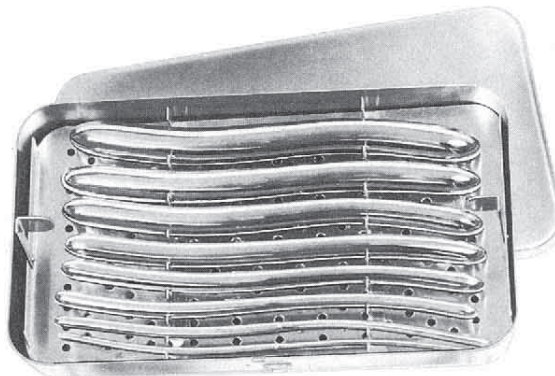

27-340-00

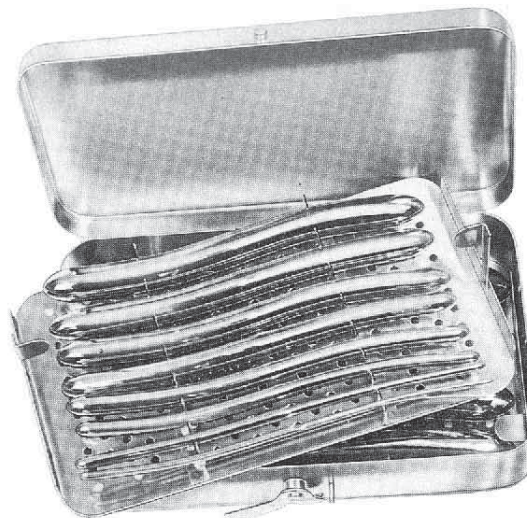

27-340-01

Set in metal case  
 Satz in Metalltui  
 Juego en estuche de metal  
 jeu en boîte métallique  
 Serie in scatola metallica

Pieces per set	set	
Stück per Satz	Satz	
Piezas por juego	juego	
Pièces par jeu	jeu	
Pezzi per serie	serie	

14	4,0-17,0 mm	27-340-00
26	1,0-26,0 mm	27-340-01



**Uterine Dilators**  
Uterus-Dilatatoren  
Dilatadores uterinos  
Dilatateurs du col de l'utérus  
Dilatatori uterini



027



¼

### HANK

- 27-340-05 Ø 4,5/ 5,0 mm
- 27-340-06 Ø 5,5/ 6,0 mm
- 27-340-07 Ø 6,5/ 7,0 mm
- 27-340-08 Ø 7,5/ 8,0 mm
- 27-340-09 Ø 8,5/ 9,0 mm
- 27-340-10 Ø 9,5/ 10,0 mm

Set , Satz , Juego , Jeu , Serie



¼

27-442-00

Set , Satz , Juego , Jeu , Serie

**Uterine Tenaculum Forceps**

Hakenzangen

Pinzas para coger el cuello del útero

Pinces pour abaissement du col de l'utérus

Pinze per abbassare il collo dell'utero



**BERNHARD**  
27-350-16  
16 cm, 6¼"



**STAUDE-MOORE**  
27-352-17  
17 cm, 6¾"



**ADAIR**  
27-354-18  
18 cm, 7"

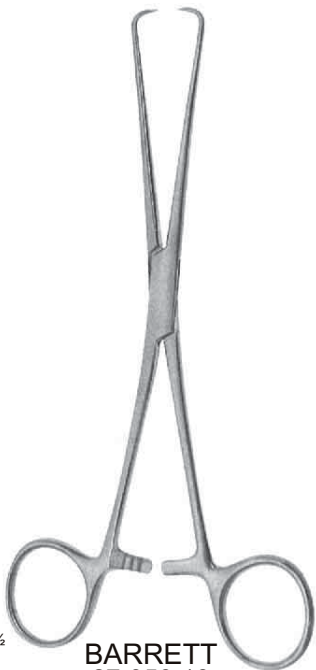

**BARRETT**  
27-356-18  
18 cm, 7"

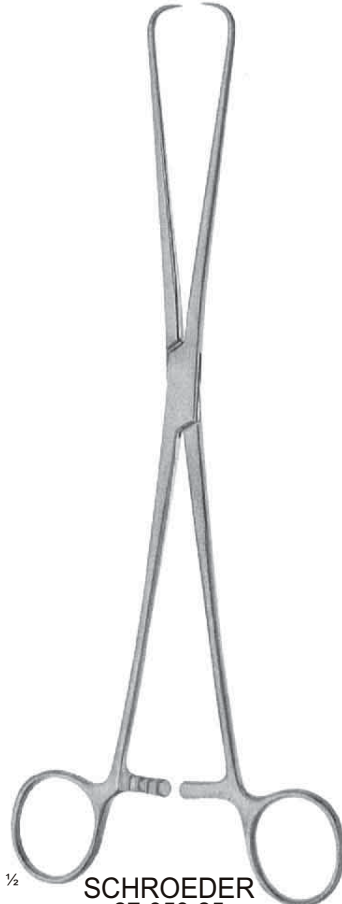

**SCHROEDER**  
27-358-25  
25 cm, 10"

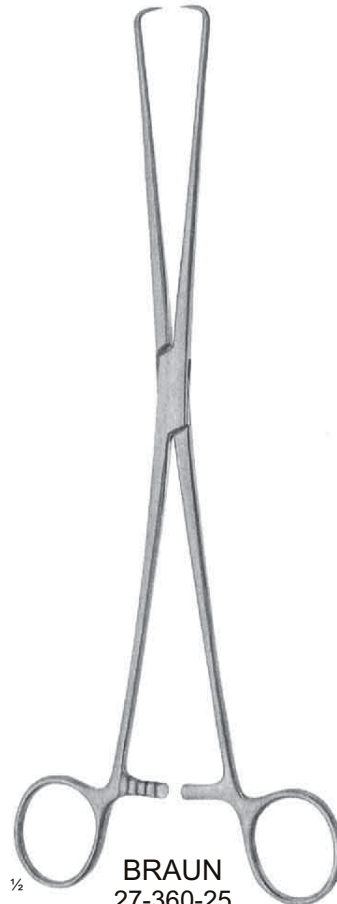

**BRAUN**  
27-360-25  
25 cm, 10"



**BEACHAM**  
29-366-26  
26 cm, 10¼"

**Amniotome for the amnion bladder**

Amniotom für die Amnionblase

Amniótomo para la vejiga amniótica

Amniotome pour le liquide amniotique

Amniótomo per la vescica amniotica

### Uterine Tenaculum Forceps

Hakenzangen

Pinzas para coger el cuello del útero

Pinces pour abaissement du col de l'utérus

Pinze per abbassare il collo dell'utero



½

**POZZI**  
27-370-25  
25,5 cm, 10"

**Heavy Pattern**  
Kräftiges Modell  
Modelo fuerte  
Modèle fort  
Modello pesante

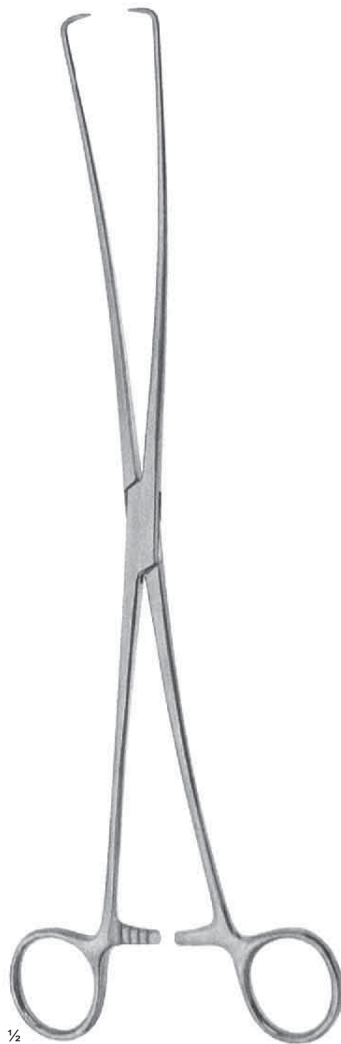

½

**DUPLAY**  
27-373-28  
28 cm, 11"



½

**SCHRODER**  
27-374-25  
25,5 cm, 10"



½

**SKENE**  
27-379-24  
24 cm, 9½"

**Uterine Tenaculum Forceps**

Hakenzangen  
 Pinzas para coger el cuello del útero  
 Pinces pour abaissement du col de l'utérus  
 Pinze per abbassare il collo dell'utero



½  
**LAHEY**  
 27-380-15  
 15 cm, 6"  
 27-380-20  
 20 cm, 8"



½  
**BRAUN**  
 27-382-15  
 15,5 cm, 6¼"



½  
**CZERNY**  
 27-386-20  
 20,5 cm, 8¼"

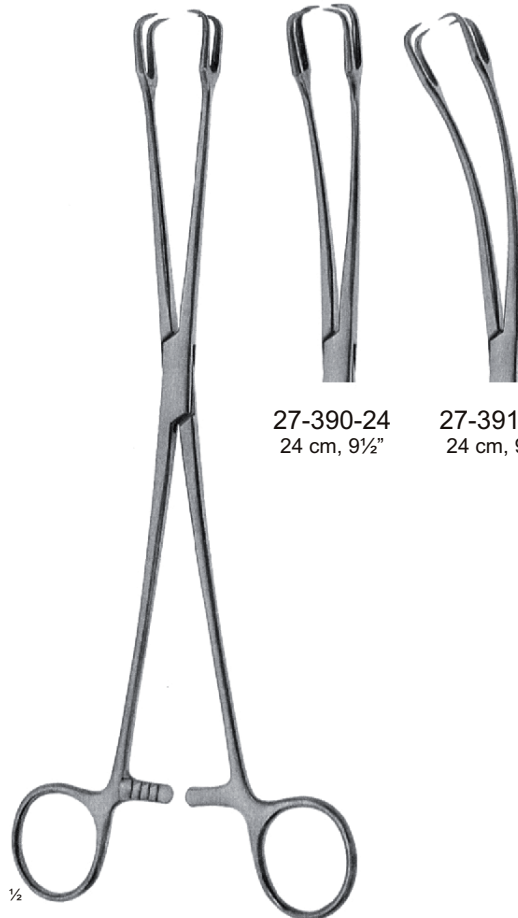

½  
**SCHROEDER**  
 27-390-24  
 27-391-24

27-390-24  
 24 cm, 9½"

27-391-24  
 24 cm, 9½"



½  
**PRATT**  
 27-398-26  
 26 cm, 10¼"

### Uterine Tenaculum Forceps

Hakenzangen  
 Pinzas para coger el cuello del útero  
 Pinces pour abaissement du col de l'utérus  
 Pinze per abbassare il collo dell'utero



**Straight**  
 Gerade  
 Rectas  
 Droits  
 Retta

**JACOBS**  
 27-400-21  
 21 cm, 8¼"

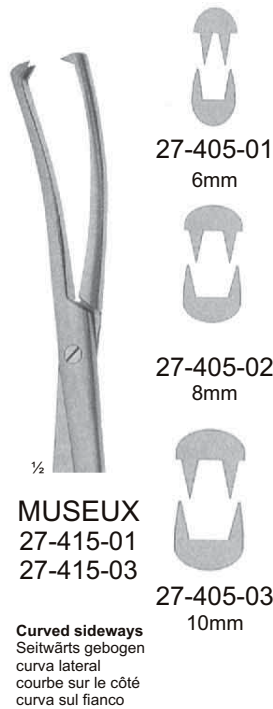

**MUSEUX**  
 27-415-01  
 27-415-03

**Curved sideways**  
 Seitwärts gebogen  
 curva lateral  
 courbe sur le côté  
 curva sul fianco

27-405-01  
 6mm

27-405-02  
 8mm

27-405-03  
 10mm



27-413-01  
 23 cm, 9"

27-413-02  
 23 cm, 9"

**Curved sideways**  
 Seitwärts gebogen  
 Curva lateral  
 Courbe sur le côté  
 Curva sul fianco

**TEALE**  
 27-413-01  
 27-413-02

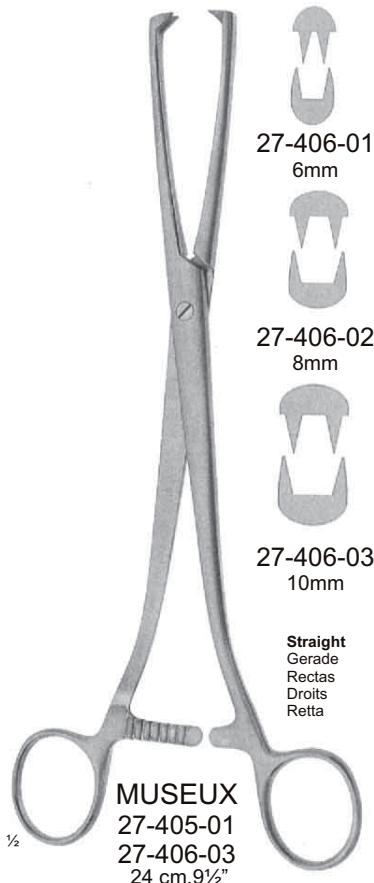

27-406-01  
 6mm

27-406-02  
 8mm

27-406-03  
 10mm

**Straight**  
 Gerade  
 Rectas  
 Droits  
 Retta

**MUSEUX**  
 27-405-01  
 27-406-03  
 24 cm, 9½"

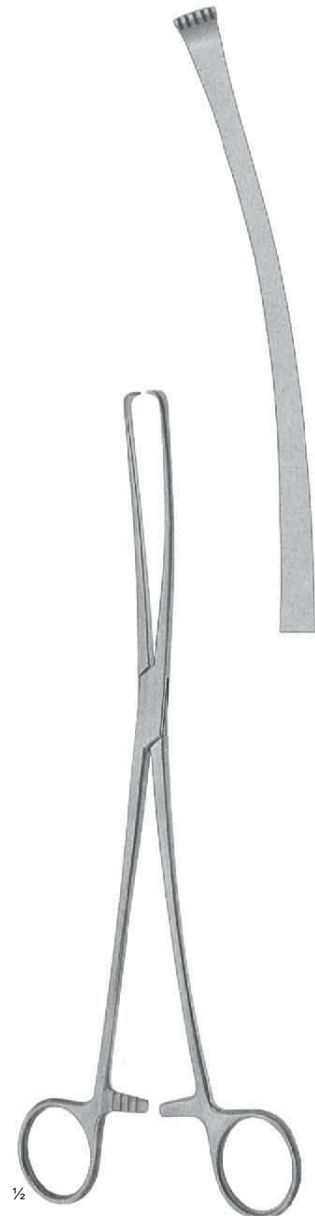

**IOWA**  
 27-413-26  
 26 cm, 10¼"

**Membrane puncturing forceps, 5x6 teeth**  
 Blasensprenger, 5x6 Zähne  
 Pinza para la vejiga amniótica 5x6 dientes  
 Pince perce membrane, 5x6 dents  
 Pinza per puntura amniotica, 5x6 denti

**Dressing and Sponge Holding Forceps**

Tupfer- und Schwammzangen  
 Pinzas para torundas y esponjas  
 Pincas à tampons et éponges  
 Pinze per tamponi e spugne

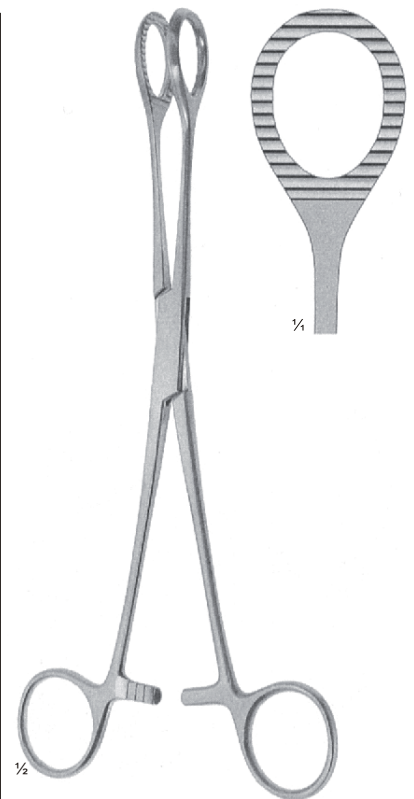
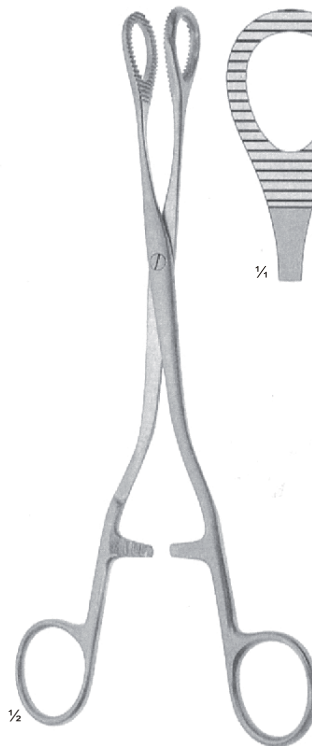
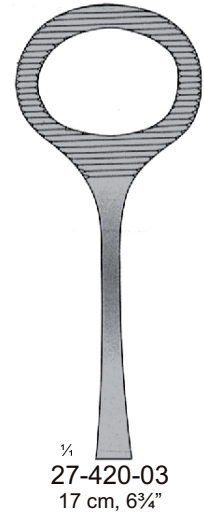
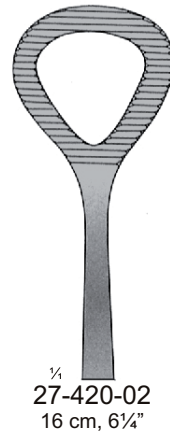
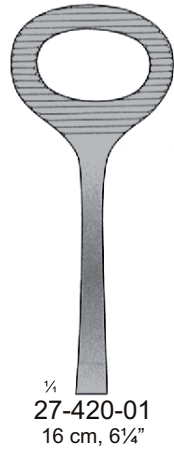

**Polypus and Ovum Forceps**

Polypen- und Ovarienzangen  
 Pinzas para pólipos uterinos y ovarios  
 Pincès à polypes et ovaires  
 Pinze per polipi e ovaie

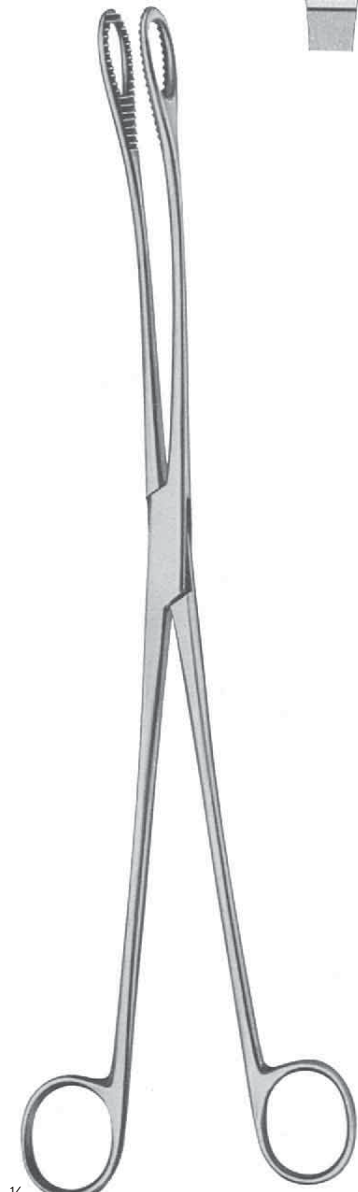

½

½

½

**NOTO**  
 27-430-20  
 20 cm, 8"

**HEYWOOD-SMITH**  
 27-432-27  
 27 cm, 10½"

**KELLY**  
 27-436-32  
 32 cm, 12½"



**Uterine Elevating Forceps**

Uterusfaßzangen  
 Pinzas para el útero  
 Pincès hystérolabes  
 Pinze per afferrare l'utero

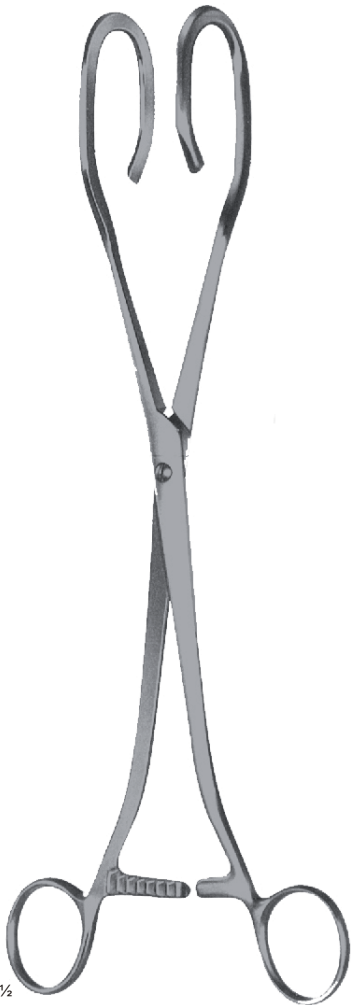
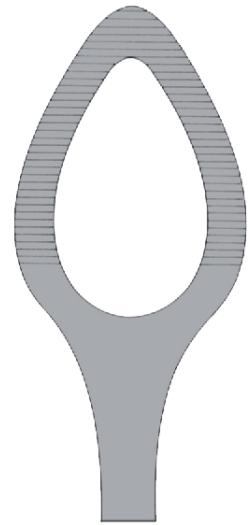
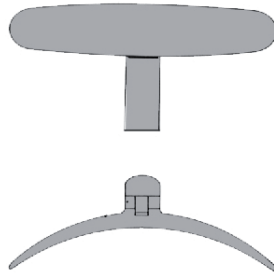

**DARTIGVES**  
 27-450-27  
 27 cm, 10½"



**COLLIN**  
 27-454-25  
 25 cm, 10"



**SOMER**  
 27-458-23  
 23 cm, 9"

**Spone and Dressing Forceps**

Kourn-und Tupferzangen  
 Pinzas para vendajes y torundas  
 Pinces à pansements et tampons  
 Pinze per medicatura e tamponi

**Biopsy Curettes**

Biopsieküretten  
 Curetas pour biopsia  
 Curettes pour biopsie  
 Curette per biopsia

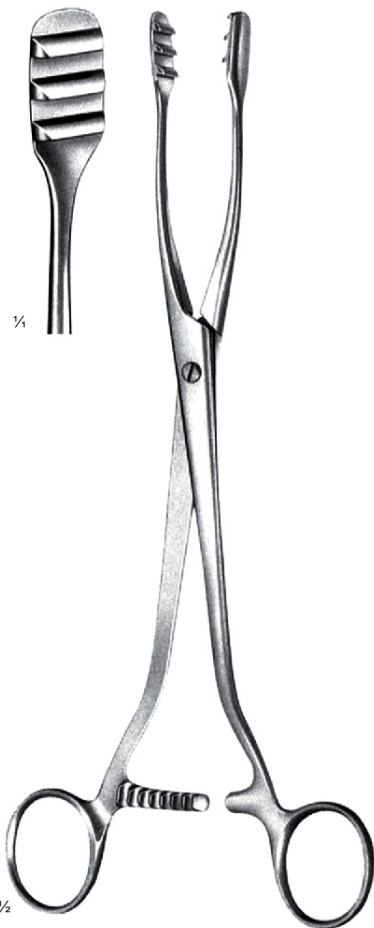

**COLLIN**  
 27-484-25  
 25 cm, 10"



**COLLIN**  
 27-488-28  
 28,5 cm, 11¼"

**Endometrial suction biopsy curette**

Endometrium-Saugbiopsiekürette

Cureta aspiradora par biopsia endo-uterina

Curette aspiratrice pour biopsie de l'endomètre

Curetta aspirante per la biopsia dell'endometrio



**RANDALL**  
 27-490-24  
 24 cm, 9½"

**Endometrial suction biopsy curette**

Endometrial-Saugbiopsiekürette

Cureta aspiradora par biopsia endo-uterina

Curette aspiratrice pour biopsie de l'endomètre

Curetta aspirante per la biopsia dell'endometrio

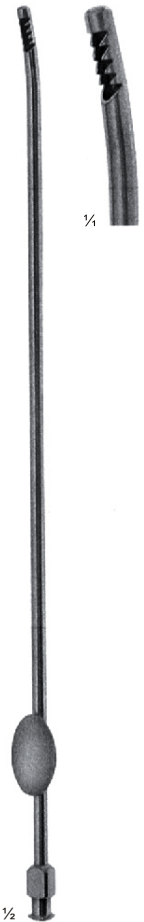

**NOVAK**  
 27-492-23  
 23 cm, 9"



**DOYEN**  
 27-494-14  
 14 cm, 5½"

**Myoma screw Ø 20 mm**  
 Mayomheber Ø 20 mm  
 Tirabuzón para mioma Ø 20 mm  
 Tracteur pour fibrome Ø 20 mm  
 Succhiello per fibroma Ø 20 mm

**DOYEN**  
 27-494-17  
 17 cm, 6¾"

**Myoma screw Ø 29 mm**  
 Mayomheber Ø 29 mm  
 Tirabuzón para mioma Ø 29 mm  
 Tracteur pour fibrome Ø 29 mm  
 Succhiello per fibroma Ø 29 mm



**SIMON**  
 27-495-22  
 22 cm, 8¾"



**SIMON**  
 27-496-22  
 22 cm, 8¾"



**SEGOND**  
 27-497-27  
 27 cm, 10¾"



**AYRE**  
 27-499-23  
 23 cm, 9"



**MOD-MUNCHEN**  
 27-500-27  
 27 cm, 10½"

**Endometrial biopsy curette**  
 Endometriustrichkürette  
 Cureta para biopsia endo-uterina  
 Curette à biopsie de l'endometre  
 Curetta per la biopsia dell'endometrio



**KEVOURKIAN YOUNGE**  
 27-502-01  
 30 cm, 12"

**Endocervical biopsy curette**  
 Endocervixbiopsiekürette  
 Cureta para biopsia endo-cerviz  
 Curette à biopsie endocervicale  
 Curetta per la biopsia endo-cervicale

**KEVOURKIAN YOUNGE**  
 27-502-02  
 30, cm, 12"



**MILLIN**  
 27-510-01  
 27-512-03

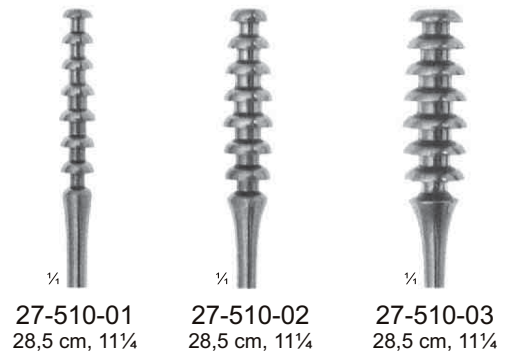

27-510-01  
 28,5 cm, 11¼"

27-510-02  
 28,5 cm, 11¼"

27-510-03  
 28,5 cm, 11¼"

**Malleable**  
 Biegsam  
 Maleables  
 Malleables  
 Malleabili

Ø5mm

Ø7mm

Ø9mm



27-512-01  
 28,5 cm, 11¼"



27-512-02  
 28,5 cm, 11¼"



27-512-03  
 28,5 cm, 11¼"

**Rigid**  
 Starr  
 Rigidas  
 Rigides  
 Rigidi

**Endocervical biopsy curettes, working portion consisting of several concave-shaped circular knives, arranged one beneath the other**

Endocervix-Biopsieküretten, Arbeitsteil bestehend aus mehreren, untereinander angeordneten konkaven rundmessern

Cureta para biopsia endo-cerviz, con cuchillos redondos colocados uno sobre otro, concavos

Curettes pour biopsie endo-cervicale constituées de plusieurs parties tranchantes circulaires concaves

Curette per la biopsia endo-cervicale, con parte attiva formata da dischi, taglienti concavi sistemati l'uno sull'altro

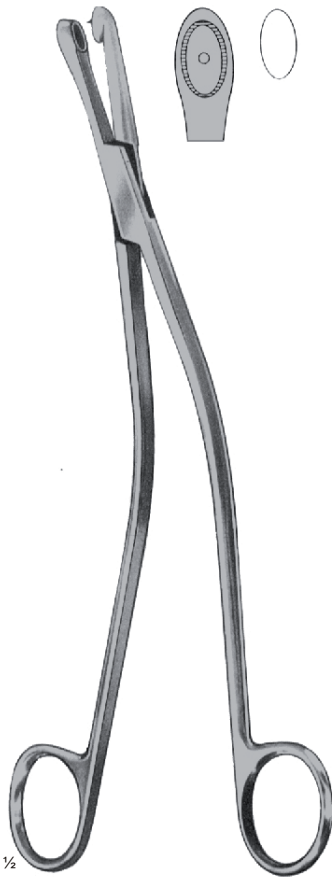

**GELLHORN**  
 27-521-23  
 23 cm, 9"



27-525-21  
 21 cm, 8 1/4"



**FAURE**  
 27-525-21  
 21 cm, 8 1/4"



27-528-21  
 21 cm, 8 1/4"

27-528-29  
 29 cm, 11 1/2"

**SCHUBERT**  
 27-528-21  
 27-528-29



¼

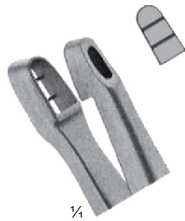

¼



¼



¼



½

**THOMAS-GAYLOR**  
 27-531-24  
 24 cm, 9½"

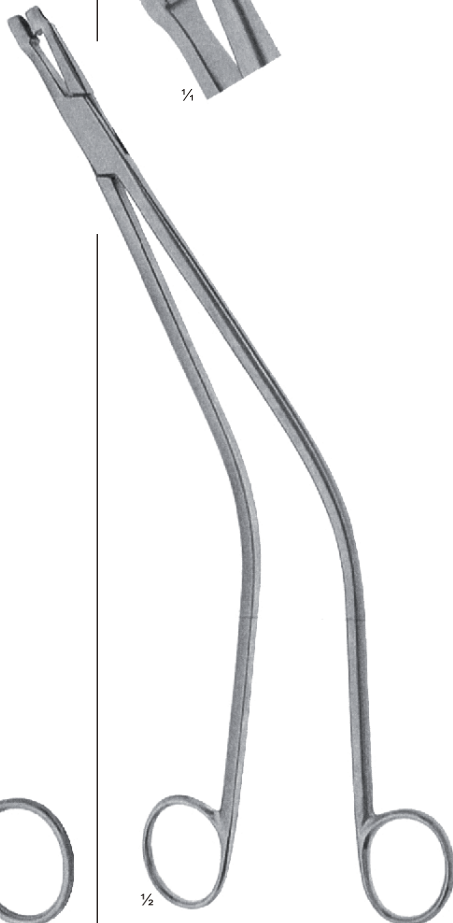

½

**SCHUBERT**  
 27-535-26  
 26 cm, 10¼"



½

**VAN-DOREN**  
 27-537-24  
 24 cm, 9½"



½

**VAN-DOREN**  
 27-539-25  
 25 cm, 10"

**Cervical biopsy and specimen forceps**  
 Uterus-Biopsiezange  
 Pinza saca-bocados para biopsia  
 Pince emporte-pièces à biopsie  
 Pinza per la biopsia cervicale e da prelievo



**Cervical Biopsy and Specimen Forceps**  
Uterus-Biopsiezangen  
Pinzas saca-bocados para biopsia  
Pincers emporte-pièces à biopsie  
Pinze per la biopsia cervicale e da prelievo



**TISCHLER**  
27-543-27  
27 cm, 10¾"



**SCHUMACHER-VAN DOREN**  
27-547-01  
27-547-02



**SEIDL DBP**  
27-551-01  
27-551-03

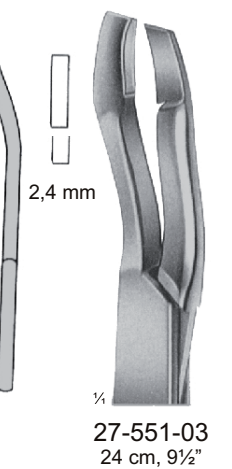
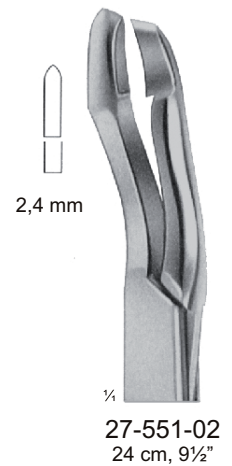
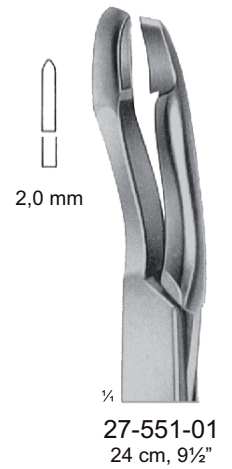

### Cervical Biopsy and Specimen Forceps

Uterus-Biopsiezangen

Pinzas saca-bocados para biopsia

Pinces emporte-pièces à biopsie

Pinze per la biopsia cervicale e da prelievo



20 cm 8"

**Jaws curved to left, with steady cut**  
 Maul nach links gebogen, mit ziehendem Schnitt  
 boca curva hacia la izquierda, con corte constante  
 Mors courbes à gauche, avec coupe constante  
 morsi curvi a sinistra, a taglio fisso

27-570-20 20 cm, 8"  
 27-570-28 28 cm, 11"

**ALEXANDER**  
 27-570-20  
 27-570-28

24,5 cm 9 1/4"

27-574-23 23 cm, 9"  
 27-574-25 25 cm, 10"

**KEVORKIAN**  
 27-574-23  
 27-574-25

24 cm, 9 1/2"

27-576-01  
 27-576-02

**Suitable for colposcopy, with steady cut**  
 für Kolposkopie geeignet, mit ziehendem Schnitt  
 apropiado para colposcopia, con corte constante  
 convient en colposcopie, avec coupe constante  
 impiegata per colposcopia, a taglio fisso

**SCHUMACHER**  
 27-576-01  
 27-576-02

18,5 cm, 7 1/4"

27-580-01 18.5 cm, 7 1/4"  
 27-580-02 18.5 cm, 7 1/4"

**Jaws straight**  
 Maul gerade  
 boca rectas  
 mors droits  
 morso retto

**Jaws curved to left, with steady cut**  
 Maul nach links gebogen, mit ziehendem Schnitt  
 boca curva hacia la izquierda, con corte constante  
 Mors courbes à gauche, avec coupe constante  
 morsi curvi a sinistra, a taglio fisso

**WITTNER**  
 27-580-01  
 27-580-02



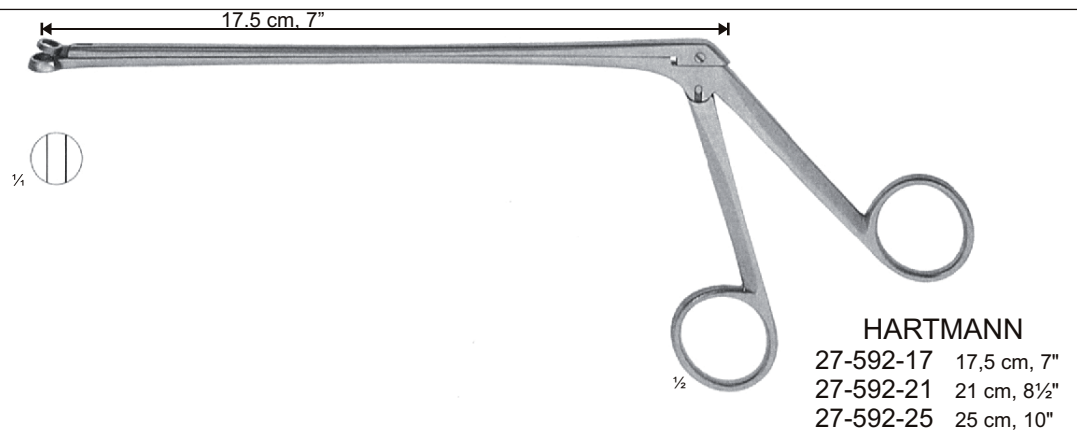
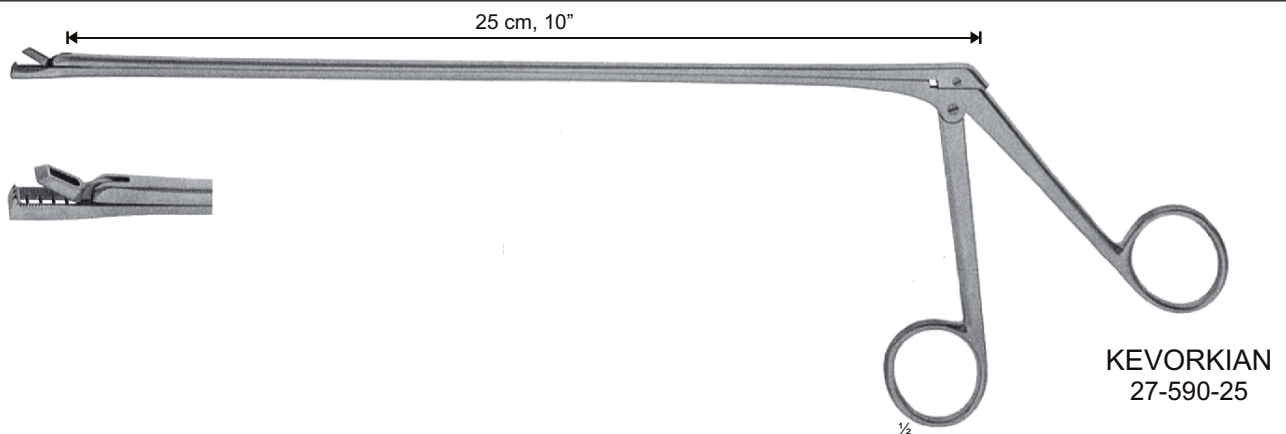
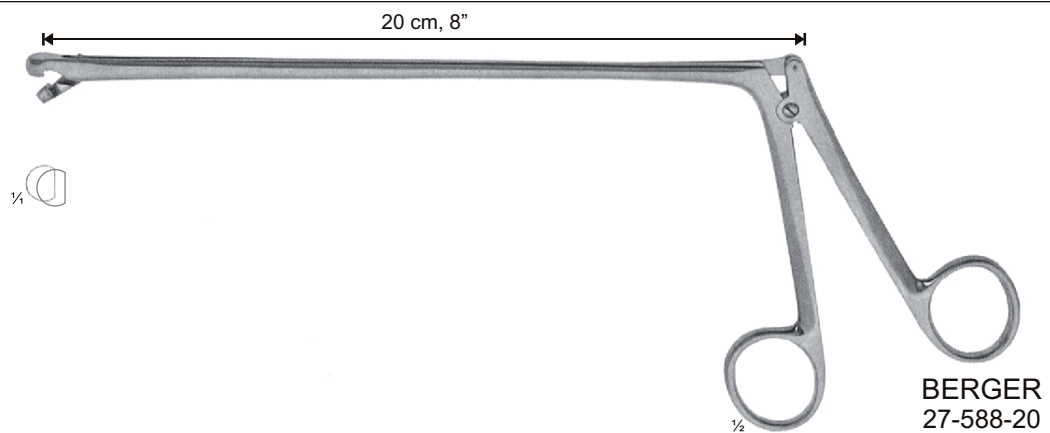
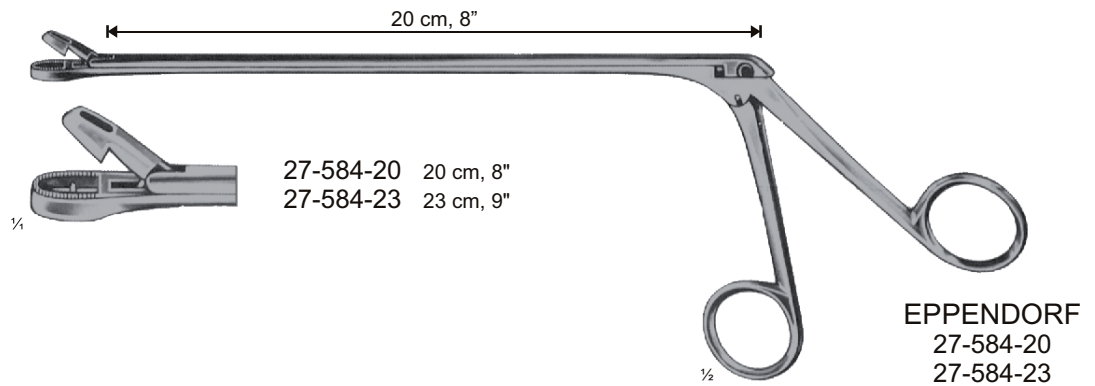



**Cervical Biopsy and Specimen Forceps**  
 Uterus-Biopsiezangen  
 Pinzas saca-bocados para biopsia  
 Pinces emporte-pièces à biopsie  
 Pinze per la biopsia cervicale e da prelievo



027

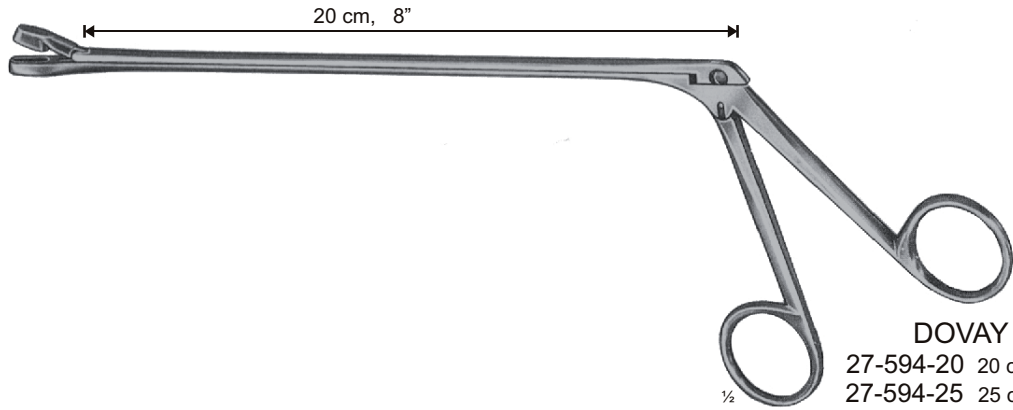

**DOVAY**

- 27-594-20 20 cm, 8"
- 27-594-25 25 cm, 10"
- 27-594-30 30 cm, 12"
- 27-594-35 35 cm, 14"
- 27-594-40 40 cm, 16"



¼

½

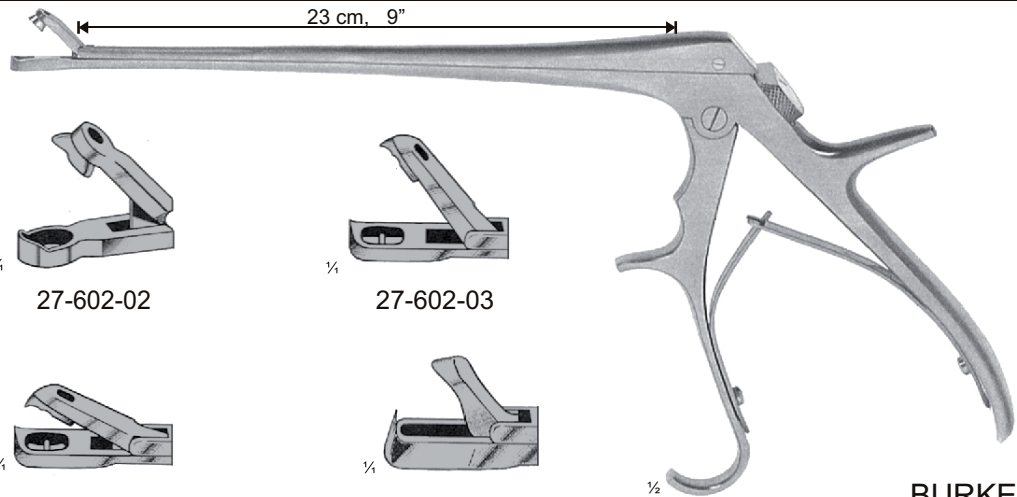

**BURKE**

- 27-602-01
- 27-602-05
- 23 cm, 9"



27-602-01

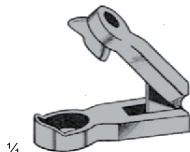

27-602-02

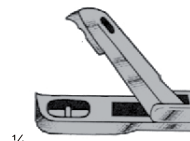

27-602-03



27-602-04



27-602-05

½

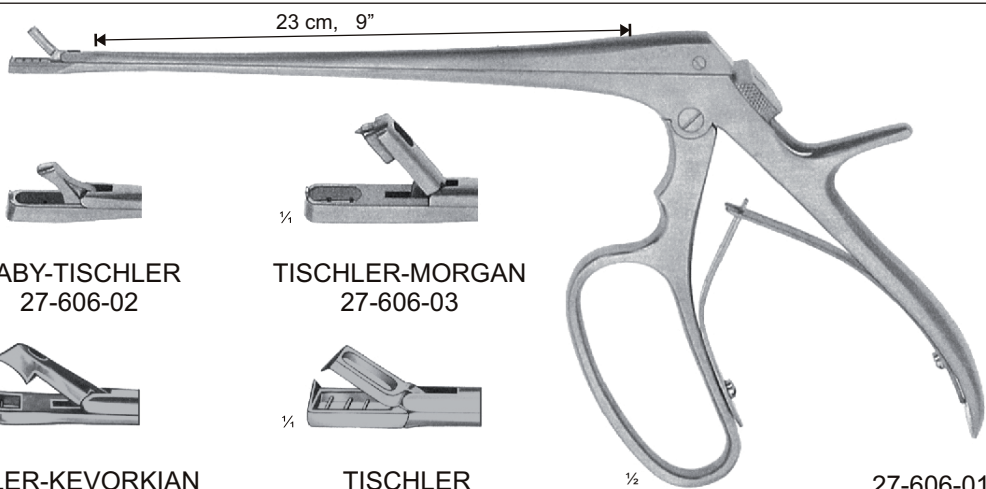

- 27-606-01
- 27-606-05
- 23 cm, 9"



KEVOURKIAN-PACEIFIC  
27-606-01



BABY-TISCHLER  
27-606-02

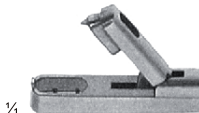

TISCHLER-MORGAN  
27-606-03



TISCHLER-KEVORKIAN  
27-606-04



TISCHLER  
27-606-05

½



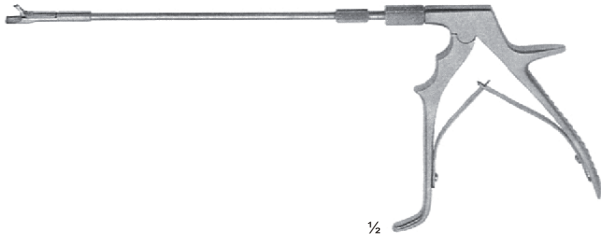









**Complete instrument**  
 Instrument komplett  
 Instrumento completo  
 Instrument complet  
 Strumento completo

**Complete instrument**  
 Instrument komplett  
 Instrumento completo  
 Instrument complet  
 Strumento completo

**Tip with tube**  
 Aufsatz mit Rohr  
 Punta con tubo  
 Tige avec embout  
 Punta con asta

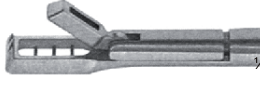
**Handle**  
 Griff  
 Mango  
 Manche  
 Manico

<b>Straight</b> Gerade Recta Droit Retta	 <b>TOWNSEND</b> 27-610-01	 <b>TISCHLER</b> 27-610-02	<b>Angled downward</b> Abwärts gewinkelt Angulada hacia abajo Angulé en dessous angolata inferiormente	27-610-23	27-610-30
<b>Angled upward</b> Aufwärts gewinkelt Angulada hacia arriba Angulé au dessus angolata superiormente	 <b>TISCHLER</b> 27-610-07	 <b>KEVOURKIAN            YOUNGE</b> 27-610-04	<b>Straight</b> Gerade Recta Droit Retta	27-610-23	27-610-30
<b>Angled downward</b> Abwärts gewinkelt Angulada hacia abajo Angulé en dessous angolata inferiormente	 <b>TOWNSEND</b> 27-610-05	 <b>KRAUSE</b> 27-610-06	<b>Straight</b> Gerade Recta Droit Retta	27-610-23	27-610-30
<b>Straight</b> Gerade Recta Droit Retta	 <b>TOWNSEND</b> 27-610-03	 <b>SCHEINMANN</b> 27-610-08	<b>Angled downward</b> Abwärts gewinkelt Angulada hacia abajo Angulé en dessous angolata inferiormente	27-610-23	27-610-30
<b>Angled upward</b> Aufwärts gewinkelt Angulada hacia arriba Angulé au dessus angolata superiormente	 <b>TISCHLER</b> 27-610-09	 <b>SCHUMACHER</b> 27-610-10	<b>Straight</b> Gerade Recta Droit Retta	27-610-23	27-610-30



13 mm  
**Blunt**  
 Stumpf  
 Romas  
 Mousse  
 Smusso

**Sharp**  
 Scharf  
 Cortantes  
 Tranchantes  
 Acuto

8 mm

**BLAKE**  
 27-622-27  
 27 cm, 10½"  
 27-622-31  
 31 cm, 12¼"

**Uterine curette**  
 Uteruskürette  
 Cureta uterina  
 Curette utérine  
 Curette uterine

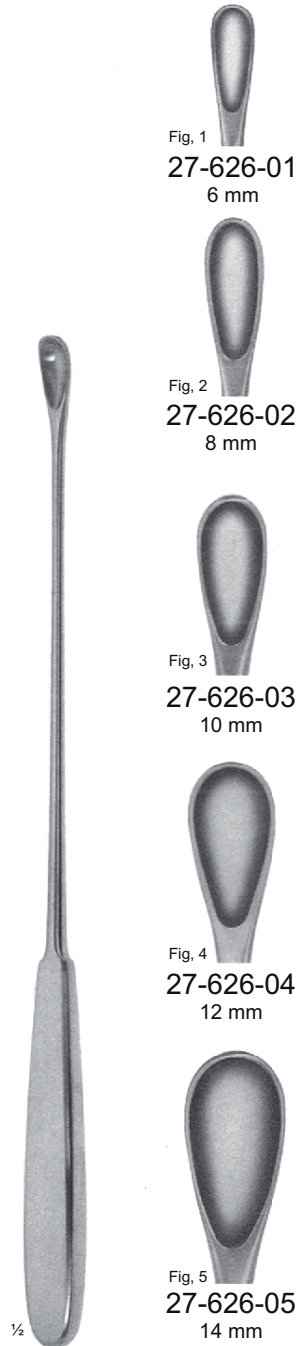

Fig. 1  
 27-626-01  
 6 mm

Fig. 2  
 27-626-02  
 8 mm

Fig. 3  
 27-626-03  
 10 mm

Fig. 4  
 27-626-04  
 12 mm

Fig. 5  
 27-626-05  
 14 mm

**GOURDET**  
 27-626-01  
 27-626-05  
 28 cm, 11"

**Uterine scoops, blunt / rigid**  
 Uteruslöffel, stumpf / fest  
 Cucharillas uterinas, romas / rígidas  
 Curétes utérines, mouses / rigides  
 Curette uterine, smusse / rigide

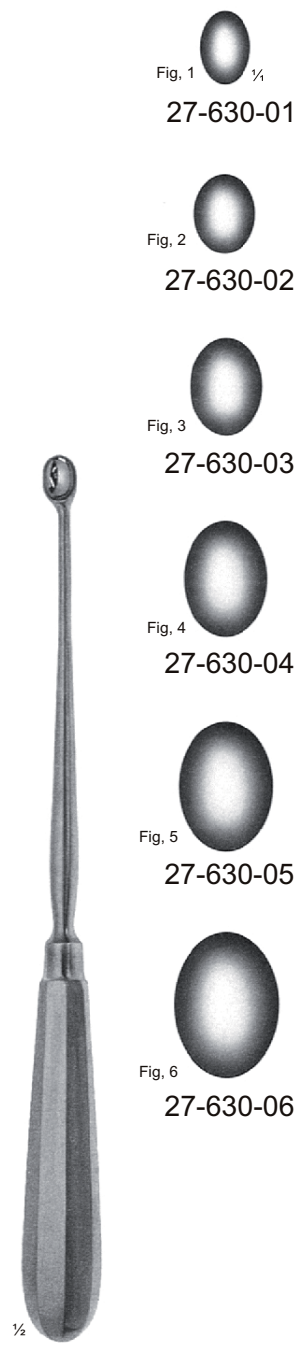

Fig. 1 ¼  
 27-630-01

Fig. 2  
 27-630-02

Fig. 3  
 27-630-03

Fig. 4  
 27-630-04

Fig. 5  
 27-630-05

Fig. 6  
 27-630-06

**SIMON**  
 27-630-01  
 27-630-06  
 25 cm, 10"

**Uterine scoops, sharp / rigid**  
 Uteruslöffel, scharf / fest  
 Cucharillas uterinas, cortante / rígidas  
 Curétes utérines, tranchantes / rigides  
 Curette uterine, acute / rigide

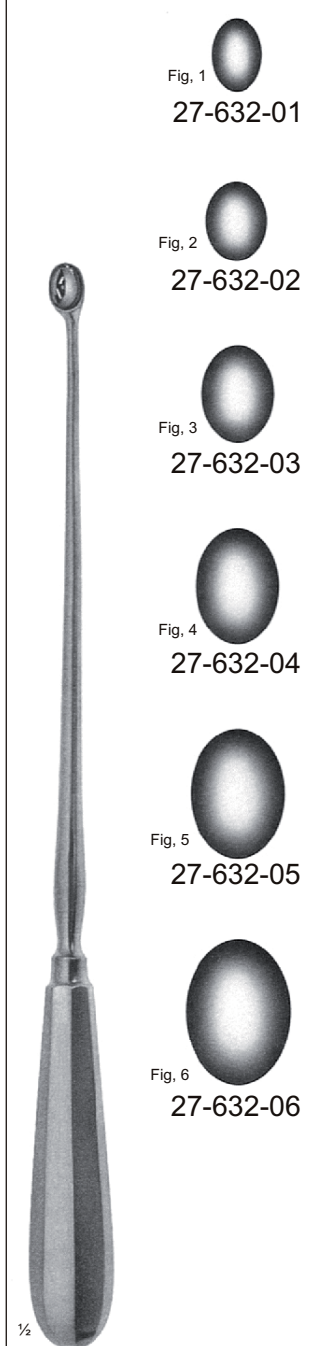

Fig. 1  
 27-632-01

Fig. 2  
 27-632-02

Fig. 3  
 27-632-03

Fig. 4  
 27-632-04

Fig. 5  
 27-632-05

Fig. 6  
 27-632-06

**SCHRODER**  
 27-632-01  
 27-632-06  
 30 cm, 12"

**Uterine scoops, sharp / rigid**  
 Uteruslöffel, scharf / fest  
 Cucharillas uterinas, cortante / rígidas  
 Curétes utérines, tranchantes / rigides  
 Curette uterine, acute / rigide



- 27-640-05 fig 00
- 27-640-06 fig 0
- 27-640-07 fig 01
- 27-640-08 fig 02
- 27-640-09 fig 03
- 27-640-11 fig 04
- 27-640-12 fig 05
- 27-640-14 fig 06
- 27-640-15 fig 07
- 27-640-16 fig 08
- 27-640-19 fig 09
- 27-640-20 fig 10
- 27-640-21 fig 11
- 27-640-23 fig 12
- 27-640-25 fig 13
- 27-640-30 fig 14
- 27-640-35 fig 15
- 27-640-40 fig 16

½

**RECAMIER**  
 27-640-05  
 27-641-40  
 31 cm, 12½"

**Blunt, rigid**  
 Stumpt, fest  
 Romas, rígidas  
 Mousse, rigides  
 Smusse, rigide

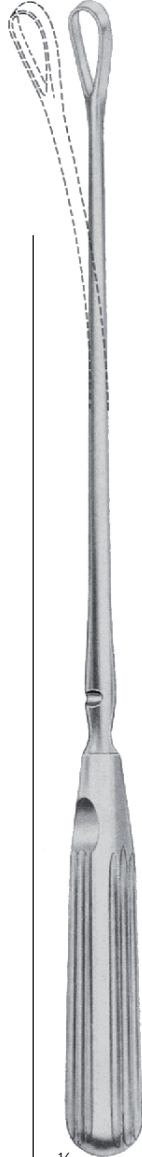

- 27-641-05 fig 00
- 27-641-06 fig 0
- 27-641-07 fig 01
- 27-641-08 fig 02
- 27-641-09 fig 03
- 27-641-11 fig 04
- 27-641-12 fig 05
- 27-641-14 fig 06
- 27-641-15 fig 07
- 27-641-16 fig 08
- 27-641-19 fig 09
- 27-641-20 fig 10
- 27-641-21 fig 11
- 27-641-23 fig 12
- 27-641-25 fig 13
- 27-641-30 fig 14
- 27-641-35 fig 15
- 27-641-40 fig 16

½

**RECAMIER**  
 27-641-05  
 27-641-40  
 31 cm, 12½"

**sharp, malleable**  
 scharf, biegsam  
 cortantes, maleables  
 tranchantes, malléables  
 acute, malleabile



- 27-644-05 fig 00
- 27-644-06 fig 0
- 27-644-07 fig 01
- 27-644-08 fig 02
- 27-644-09 fig 03
- 27-644-11 fig 04
- 27-644-12 fig 05
- 27-644-14 fig 06
- 27-644-15 fig 07
- 27-644-16 fig 08
- 27-644-19 fig 09
- 27-644-20 fig 10
- 27-644-21 fig 11
- 27-644-23 fig 12
- 27-644-25 fig 13
- 27-644-30 fig 14
- 27-644-35 fig 15
- 27-644-40 fig 16

½

**RECAMIER**  
 27-644-05  
 27-644-40  
 31 cm, 12½"

**Blunt, rigid**  
 Stumpt, fest  
 Romas, rígidas  
 Mousse, rigides  
 Smusse, rigide

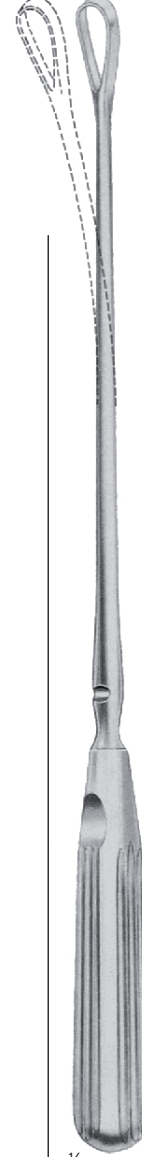

- 27-645-05 fig 00
- 27-645-06 fig 0
- 27-645-07 fig 01
- 27-645-08 fig 02
- 27-645-09 fig 03
- 27-645-11 fig 04
- 27-645-12 fig 05
- 27-645-14 fig 06
- 27-645-15 fig 07
- 27-645-16 fig 08
- 27-645-19 fig 09
- 27-645-20 fig 10
- 27-645-21 fig 11
- 27-645-23 fig 12
- 27-645-25 fig 13
- 27-640-30 fig 14
- 27-640-35 fig 15
- 27-640-40 fig 16

½

**RECAMIER**  
 27-645-05  
 27-645-40  
 31 cm, 12½"

**sharp, malleable**  
 scharf, biegsam  
 cortantes, maleables  
 tranchantes, malléables  
 acute, malleabile



½

- 27-650-05 fig 00
- 27-650-06 fig 0
- 27-650-07 fig 01
- 27-650-08 fig 02
- 27-650-09 fig 03
- 27-650-11 fig 04
- 27-650-12 fig 05
- 27-650-14 fig 06
- 27-650-15 fig 07
- 27-650-16 fig 08
- 27-650-19 fig 09
- 27-650-20 fig 10
- 27-650-21 fig 11
- 27-650-23 fig 12
- 27-650-25 fig 13
- 27-650-30 fig 14
- 27-650-35 fig 15
- 27-650-40 fig 16

**SIMS**  
 27-650-05  
 27-650-40  
 31 cm, 12½"

**Blunt, rigid**  
 Stumpf, fest  
 Romas, rígidas  
 Mousses, rigides  
 Smusse, rigide

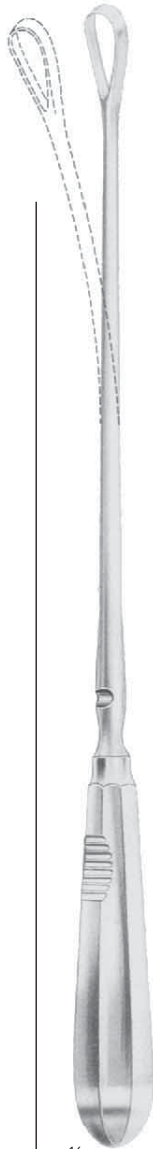

½

- 27-651-05 fig 00
- 27-651-06 fig 0
- 27-651-07 fig 01
- 27-651-08 fig 02
- 27-651-09 fig 03
- 27-651-11 fig 04
- 27-651-12 fig 05
- 27-651-14 fig 06
- 27-651-15 fig 07
- 27-651-16 fig 08
- 27-651-19 fig 09
- 27-651-20 fig 10
- 27-651-21 fig 11
- 27-651-23 fig 12
- 27-651-25 fig 13
- 27-651-30 fig 14
- 27-651-35 fig 15
- 27-651-40 fig 16

**SIMS**  
 27-651-05  
 27-651-40  
 31 cm, 12½"

**sharp, malleable**  
 scharf, biegsam  
 cortantes, maleables  
 tranchantes, malléables  
 acute, malleabile



½

- 27-654-05 fig 00
- 27-654-06 fig 0
- 27-654-07 fig 01
- 27-654-08 fig 02
- 27-654-09 fig 03
- 27-654-11 fig 04
- 27-654-12 fig 05
- 27-654-14 fig 06
- 27-654-15 fig 07
- 27-654-16 fig 08
- 27-654-19 fig 09
- 27-654-20 fig 10
- 27-654-21 fig 11
- 27-654-23 fig 12
- 27-654-25 fig 13
- 27-654-30 fig 14
- 27-654-35 fig 15
- 27-654-40 fig 16

**SIMS**  
 27-654-05  
 27-654-40  
 31 cm, 12½"

**Blunt, rigid**  
 Stumpf, fest  
 Romas, rígidas  
 Mousses, rigides  
 Smusse, rigide

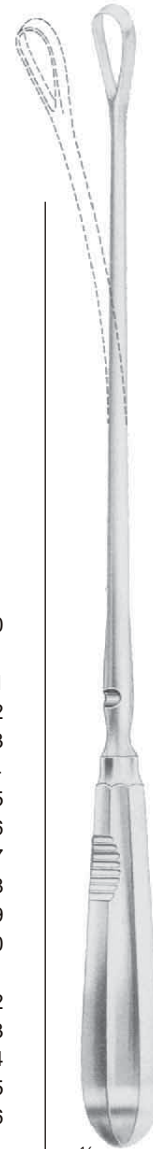

½

- 27-655-05 fig 00
- 27-655-06 fig 0
- 27-655-07 fig 01
- 27-655-08 fig 02
- 27-655-09 fig 03
- 27-655-11 fig 04
- 27-655-12 fig 05
- 27-655-14 fig 06
- 27-655-15 fig 07
- 27-655-16 fig 08
- 27-655-19 fig 09
- 27-655-20 fig 10
- 27-655-21 fig 11
- 27-655-23 fig 12
- 27-655-25 fig 13
- 27-655-30 fig 14
- 27-655-35 fig 15
- 27-655-40 fig 16

**SIMS**  
 27-655-05  
 27-655-40  
 31 cm, 12½"

**sharp, malleable**  
 scharf, biegsam  
 cortantes, maleables  
 tranchantes, malléables  
 acute, malleabile

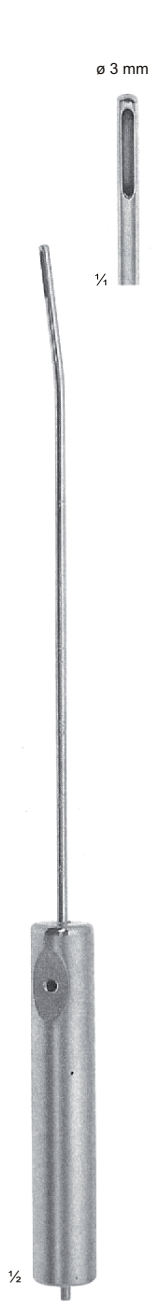

27-666-03  
 28,5 cm, 11¼"



27-666-04  
 28,5 cm, 11¼"



27-666-06  
 28,5 cm, 11¼"



27-666-08  
 28,5 cm, 11¼"

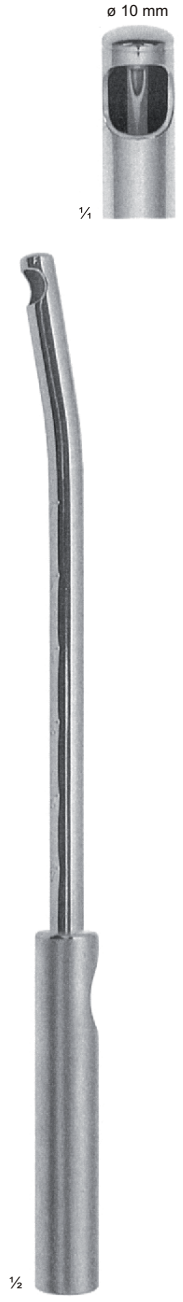

27-666-10  
 28,5 cm, 11¼"

**Specimen and aspirating curettes**  
 Probe- und absaugküretten  
 Curetas de biopsia y de aspiración  
 Curettes à biopsie et d'aspiration  
 Curette per prelieve ed aspirazione

**Aspirating curettes**  
 Absaugküretten  
 Curetas de aspiración  
 Curettes d'aspiration  
 Curette per aspirazione



ø 12 mm



27-666-12  
 28,5 cm, 11¼"

ø 14 mm



27-666-14  
 28,5 cm, 11¼"



27-680-00

**Coupling piece for the connection of aspirating currettes 27-666-03\_27-666-14 to flexible tube having an interior diameter of 11 mm**

Schlauchverbindungsstück für Absaugküretten 27-666-03 bis 27-666-14, für Saugschlauch von 11 mm Innen-ø

Adaptador de tubo para curetas de aspiración 27666-03-27-666-14 para tubos de aspiración. Ø interior de 11 mm

Embout adaptable aux curettes 27-666-03\_27-666-14 pour tube d'aspiration, ø inférieur à 11 mm

Adattatore per la connessione delle curette per aspirazione 27-666-03\_27-666-14 ad un tubo flessibile avente un ø int. di 11 mm



Fig. 1  
 27-690-01  
 10mm



Fig. 2  
 27-690-02  
 12mm



Fig. 3  
 27-690-03  
 14mm



GREENE  
 27-690-01  
 27-690-03  
 28 cm, 11½"