

025



**Gall, Liver, Kidney, Bladder, Urology  
Galle, Leber, Niere, Blase, Urologie  
Bilis, Hígado, Riñón, Vejiga, Urología  
Bile, Foie, Rein, Vessie, Urologie  
Bile, Fegato, Rene, Vescica, Urologia**

## Gall Duct Probes

Gallengangsonden  
Sondas para el conducto biliar  
Dilatateurs à voies biliaires  
Dilatatori per condotti biliari



025



25-102-04  
ø 4,2 mm

¼



25-102-06  
ø 6,0 mm

¼



25-102-07  
ø 7,0 mm

¼

### Gall duct probes flexible

Gallengangsonden federn

Sondas para el conducto biliar, flexible

Dilatateurs à voies biliaires flexible

Dilatatore per condotti biliari flessibili

### DESJARDINS

25-102-04  
25-102-07  
28 cm, 11"

ø 5,0 mm



Ø 5mm

½

### MOYNIHAN

25-106-34  
34 cm, 13½"

### Gall stone probe and scoop of tin, malleable

Gallensteinsonde und -löffel aus zinn, biegsam

Sonda y cucharilla para los cálculos biliares, maleable

Sonde-curette pour vésicule biliaire, malléable

Sonda con cucchiaino per calcoli biliari, malleabile

ø 3,5 mm

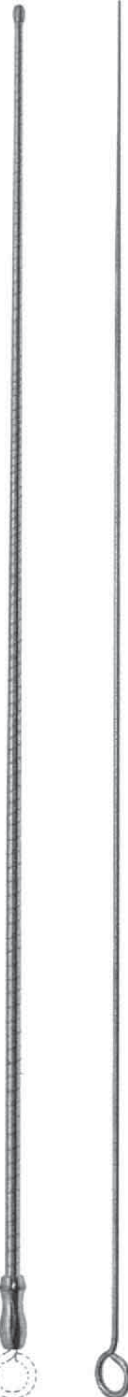

Ø 3.5mm

½

### OCHSNER

25-108-38  
38 cm, 15¼"

### Gall duct probes flexible

Gallengangsonde, federn

Sonda para el conducto biliar, flexible

Dilatateur à voies biliaires flexible avec conducteur

Dilatatore per condotti biliari flessibile



### Common Bile Duct Dilators

Gallengang-Dilatationsoliven  
Dilatadores para el conducto biliar  
Dilatateurs biliaries  
Dilatatore per coledoco



025

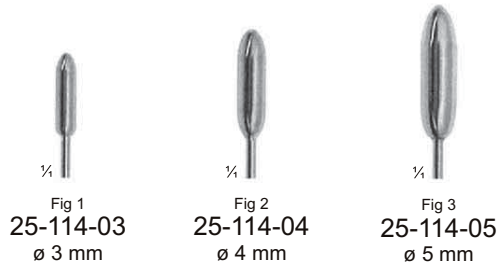

Fig 1  
25-114-03  
ø 3 mm

Fig 2  
25-114-04  
ø 4 mm

Fig 3  
25-114-05  
ø 5 mm

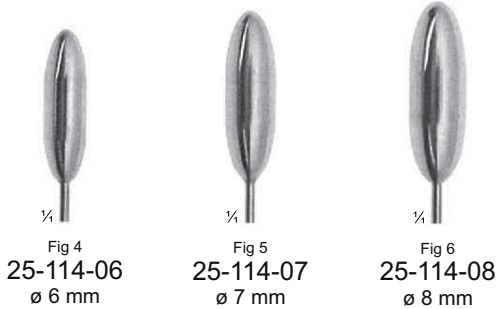

Fig 4  
25-114-06  
ø 6 mm

Fig 5  
25-114-07  
ø 7 mm

Fig 6  
25-114-08  
ø 8 mm

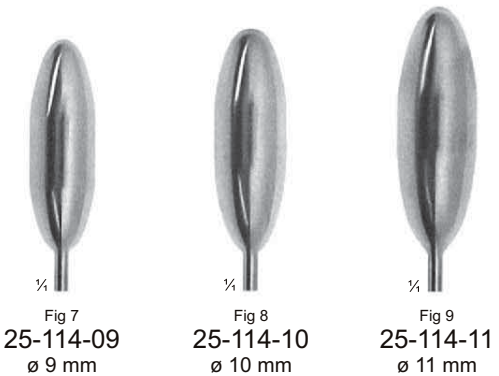

Fig 7  
25-114-09  
ø 9 mm

Fig 8  
25-114-10  
ø 10 mm

Fig 9  
25-114-11  
ø 11 mm

**BAKES**  
25-114-03  
25-116-11  
30 cm 12"

**BAKES**  
25-114-00  
Set , Setz , Juego , Jeu , Serie

Set of 9 common bile duct dilators 25-114-03 to 25-114-11 malleable, in plastic roll (25-114-00)

Satz von 9 Gallengang-Dilatationsoliven 25-114-03 bis 25-114-11 biegsam, in Plastiktasche (25-114-00)

Juego de 9 dilatadores para el conducto biliar del 25-114-03 al 25-114-11 maleable, en bolsa de plástico (25-114-00)

Jeu de 9 dilatateurs biliaries du 25-114-03 au 25-114-11 malléables en sachet plastique (25-114-00)

Set di 9 dilatatori per condotti biliari dal 25-114-03 al 25-114-11 malleabili, con rotolo di plastica (25-114-00)

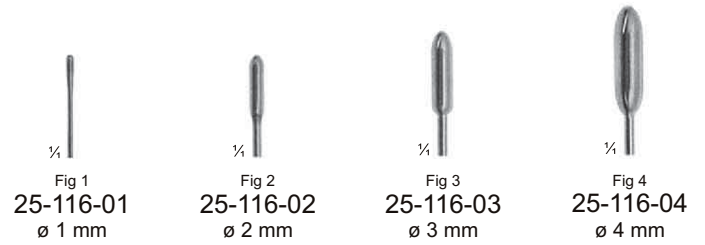

Fig 1  
25-116-01  
ø 1 mm

Fig 2  
25-116-02  
ø 2 mm

Fig 3  
25-116-03  
ø 3 mm

Fig 4  
25-116-04  
ø 4 mm

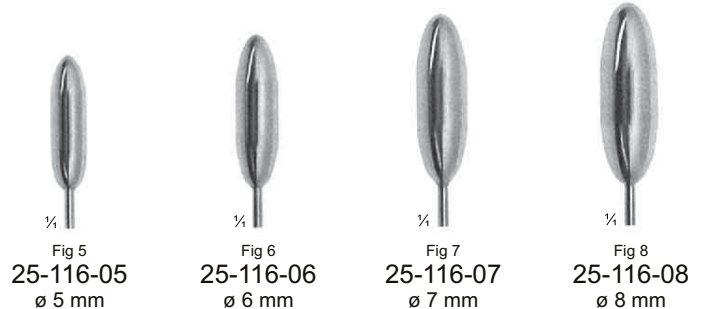

Fig 5  
25-116-05  
ø 5 mm

Fig 6  
25-116-06  
ø 6 mm

Fig 7  
25-116-07  
ø 7 mm

Fig 8  
25-116-08  
ø 8 mm

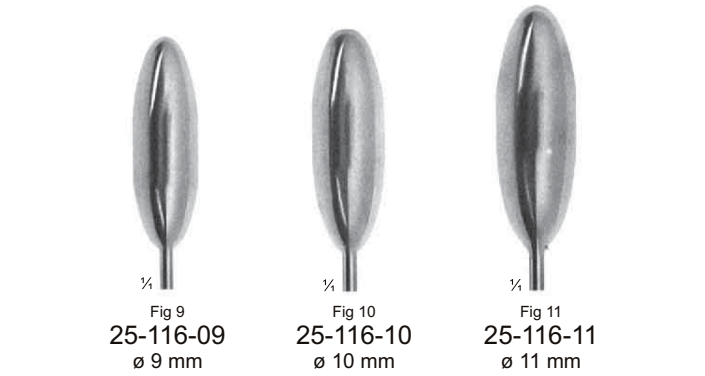

Fig 9  
25-116-09  
ø 9 mm

Fig 10  
25-116-10  
ø 10 mm

Fig 11  
25-116-11  
ø 11 mm

**BAKES**  
25-116-01  
25-116-13  
30 cm 12"

Fig 12  
25-116-12  
ø 12 mm

Fig 13  
25-116-13  
ø 13 mm

**BAKES**  
25-116-00  
Set , Setz , Juego , Jeu , Serie

Set of 13 common bile duct dilators 25-116-01 to 25-116-13 malleable, in plastic roll (25-116-00)

Satz von 13 Gallengang-Dilatationsoliven 25-116-01 bis 25-116-13 biegsam, in Plastiktasche (25-116-00)

Juego de 13 dilatadores para el conducto biliar del 25-116-01 al 25-116-13 maleable, en bolsa de plástico (25-116-00)

Jeu de 13 dilatateurs biliaries du 25-116-01 au 25-116-13 malléables en sachet plastique (25-116-00)

Set di 13 dilatatori per condotti biliari dal 25-116-01 al 25-116-13 malleabili, con rotolo di plastica (25-116-00)

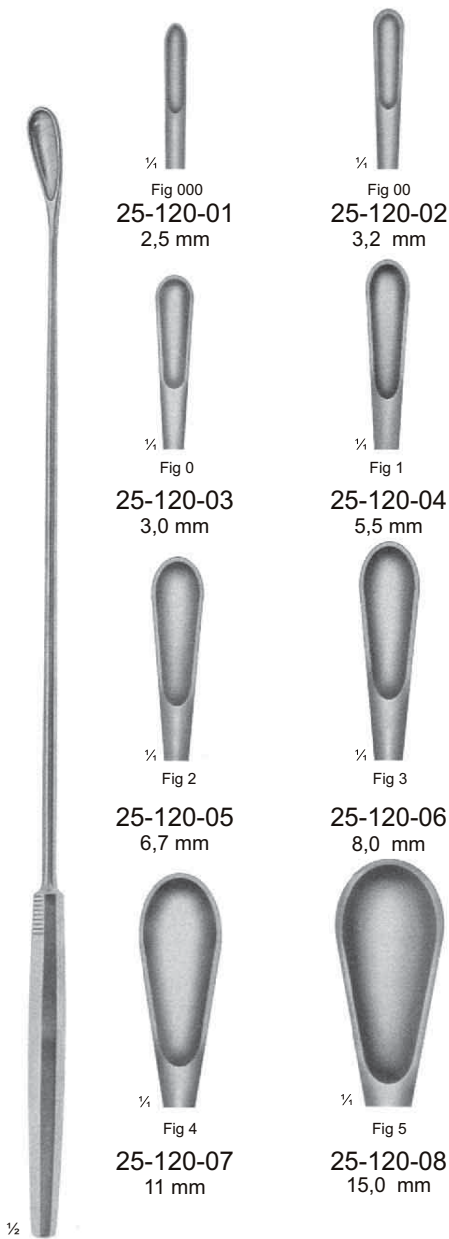

**LUER-KOERTE**  
 25-120-01  
 25-120-08  
 32 cm, 12¾"

**Gall stone scoops, malleable**  
 Gallensteinlöffel, biegsam  
 Cucharillas para los cálculos biliares, maleable  
 Curettes pour calculs biliaires, malléables  
 Cucchiaini per calcoli biliari, malleabili



**MAYO**  
 25-124-28  
 28 cm, 11"

**Gall stone scoops**  
 Gallensteinlöffel  
 Cucharillas para los cálculos biliares  
 Curettes pour calculs biliaires  
 Cucchiaini per calcoli biliari



**MOORE**  
 25-128-28  
 28 cm, 11"

**Gall bladder scoop**  
 Gallenblasenlöffel  
 Cucharilla para la vesícula biliar  
 Cuillère pour vésicule biliaire  
 Cucchiaino per colecisti



**Gall Stone Forceps**

Gallensteinzangen  
Pinzas para los cálculos biliares  
Pinces pour calculs biliaires  
Pince per calcoli biliari



025

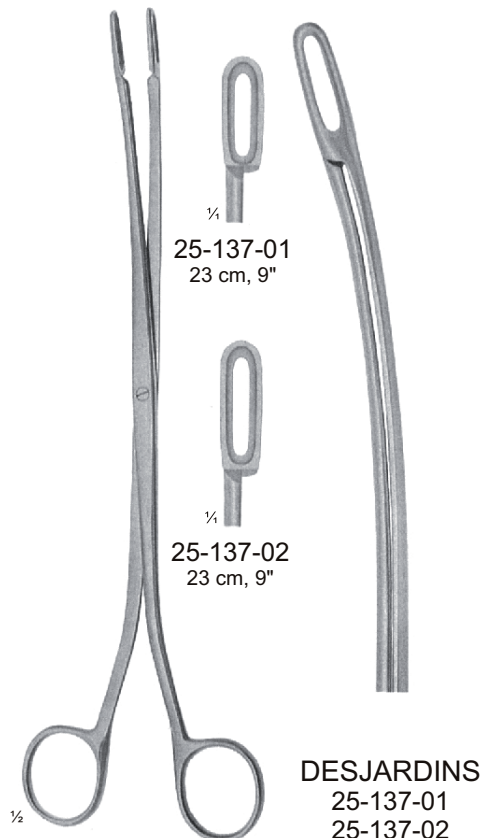
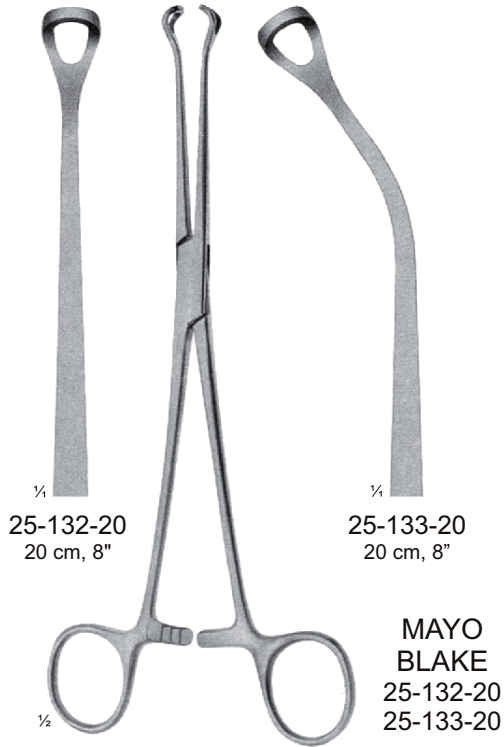
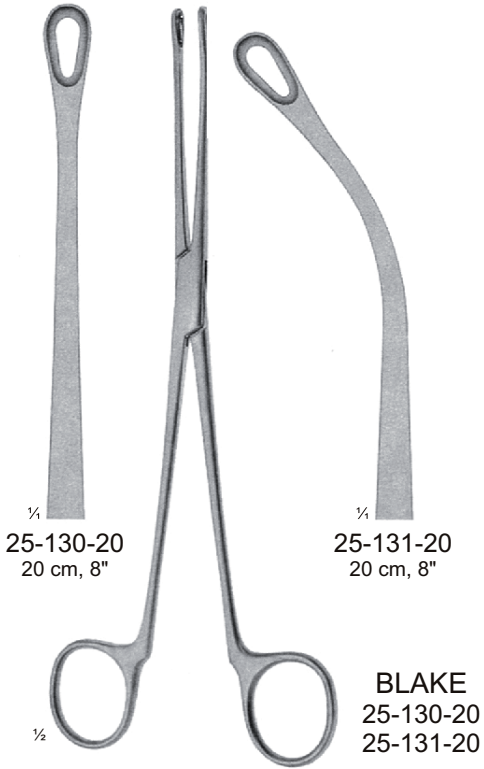

**DARTIGUES**  
25-150-27  
27 cm, 10¼"

**Kidney elevating forceps**  
Nierenfaßzange  
Pinza para sostener el riñón  
Hystérolabe  
Pinza per afferrare il rene





### Kidney Stone Forceps

Nierensteinzangen  
Pinzas para los cálculos renales  
Pinces pour les calculs rénaux  
Pinze per calcoli renali



025



25-155-01  
23 cm, 9"



25-155-02  
22 cm, 8¾"



25-155-03  
22 cm, 8¾"

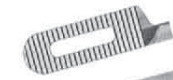

25-155-04  
22 cm, 8¾"



25-157-01  
19 cm, 7½"



25-157-02  
19 cm, 7½"



RANDALL  
25-155-01  
25-155-04

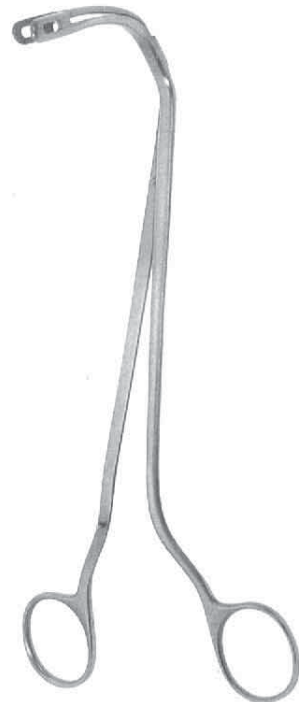

RANDALL  
25-157-01  
25-157-02

**Kidney Stone Forceps**  
Nierensteinzangen  
Pinzas para los cálculos renales  
Pinces pour les calculs rénaux  
Pinze per calcoli renali



**ELSASSER**  
 25-170-20  
 20 cm, 8"



**ELSASSER**  
 25-172-20  
 20 cm, 8"

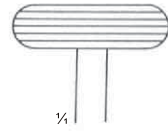

**25-184-01**  
 23 cm, 9"  
 Fig. 1



**25-184-02**  
 23 cm, 9"  
 Fig. 2

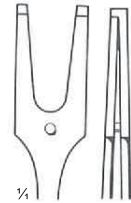

**25-184-03**  
 24 cm, 9½"  
 Fig. 3



**MILLIN**  
 25-180-23  
 23 cm, 9¼"



**MILLIN**  
 25-182-24  
 24,5 cm, 9¾"



**MILLIN**  
 25-184-01  
 25-184-03



**Prostatic Retractors**  
Prostatahaken  
Separadores para la prostata  
Ecarteurs prostatiques  
Retractori prostatici



025



¼

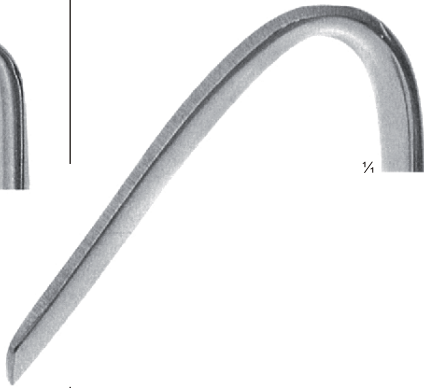

¼



¼



¼

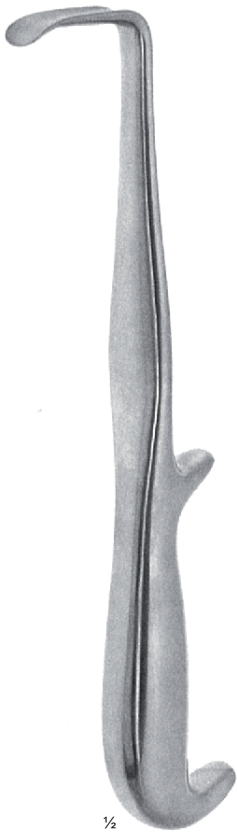

½

**YOUNG**  
25-190-21  
21,5 cm, 8½"

**lateral**  
lateral  
lateral  
latéral  
laterale



½

**YOUNG**  
25-192-21  
21 cm, 8½"

**anterior**  
anterior  
anterior  
antérieur  
anteriore



½

**YOUNG**  
25-194-22  
22 cm, 8¾"

**Bulbus hook**  
Bulbus-Haken  
Gancho para el bulbus  
Crochet en bulbus  
Bulbo ad uncino



½

**YOUNG**  
25-196-21  
21 cm, 8½"

**forked**  
gegabelt  
horquilla  
en fourche  
a forchetta





**Bladder Retractors**  
Blasenwundspreizer  
Separadores vesicales  
Ecarteurs vésicaux  
Divaricatori vescicali



025

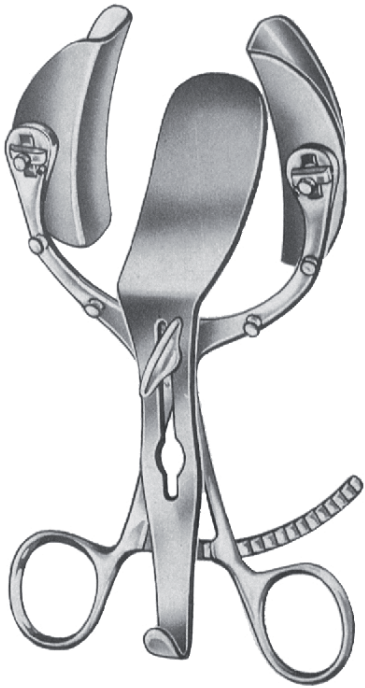

**LEGUEU**  
25-200-00

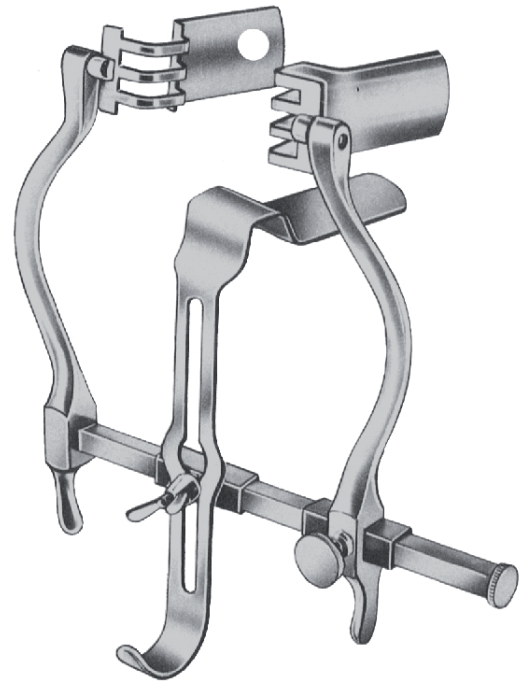

**JUDD-MASSON**  
25-202-00

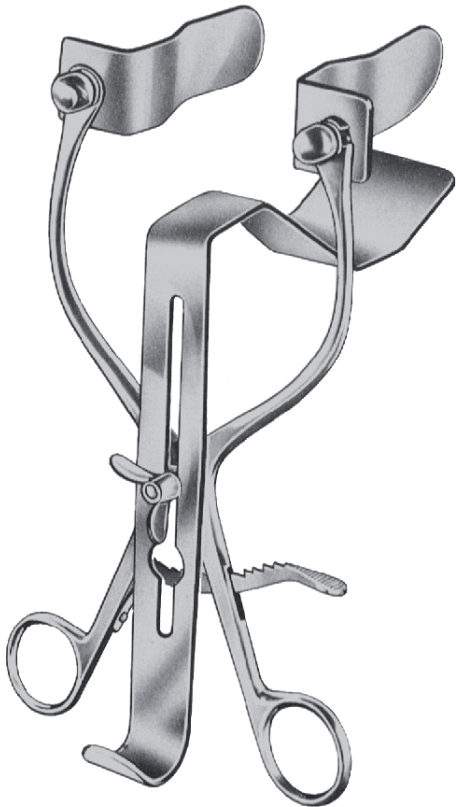

**MILLIN**  
25-204-00



**MILLIN**  
25-206-00

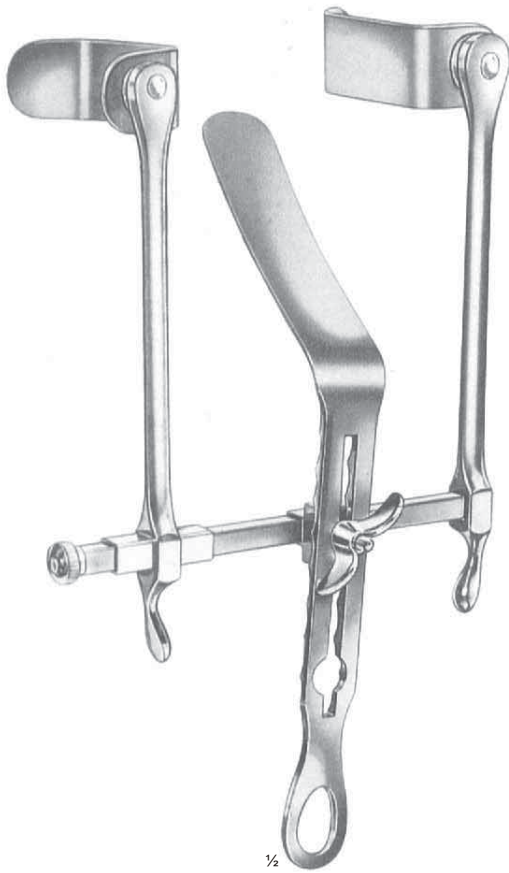

**TOMSON-WALKER**  
 25-210-00

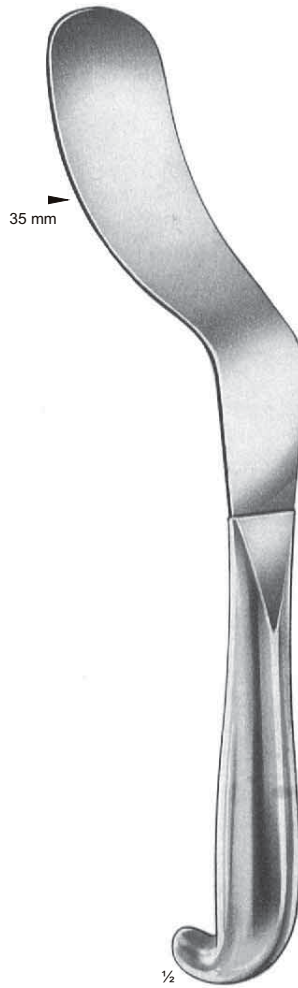

**LEGUEU**  
 25-212-27  
 27 cm, 10 1/2"



**MILLIN**  
 25-214-29  
 29,5 cm, 11 3/4"

**Bladder neck spreader**  
 Blasenhalsspreizer  
 Dilatador para el cuello vesical  
 Dilatateur vésicale  
 Dilatatore per collo vescicale



**Dilating Bougies**  
 Dilatationsbougies  
 Bujías dilatadoras  
 Bougies dilatatrices  
 Candelette dilatatrici

**Metal Catheters**  
 Metallkatheter  
 Sondas metálicas  
 Sondes vésicales métalliques  
 Cateteri metallici



025



1/2



1/2



1/2



1/2

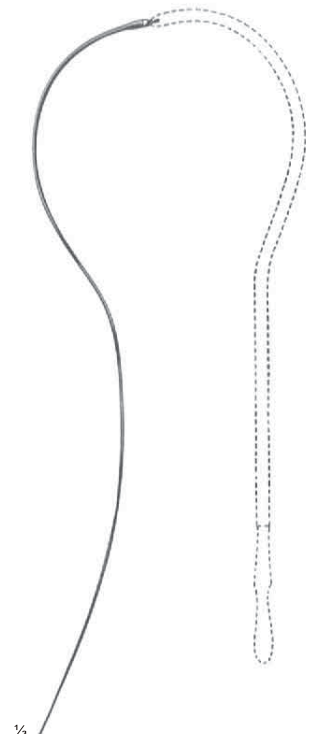

1/2

**VAN BUREN**

|                  | Ø mm   | Chr. (French) |
|------------------|--------|---------------|
| 27,5 mm, 10 3/4" |        |               |
| 25-220-08        | 2 1/4  | 8             |
| 25-220-09        | 3      | 9             |
| 25-220-10        | 3 1/2  | 10            |
| 25-220-12        | 4      | 12            |
| 25-220-14        | 4 1/2  | 14            |
| 25-220-16        | 5 1/2  | 16            |
| 25-220-18        | 6      | 18            |
| 25-220-20        | 6 1/2  | 20            |
| 25-220-22        | 7 1/2  | 22            |
| 25-220-24        | 8      | 24            |
| 25-220-26        | 8 1/2  | 26            |
| 25-220-28        | 9 1/2  | 28            |
| 25-220-30        | 10     | 30            |
| 25-220-32        | 10 1/2 | 32            |
| 25-220-34        | 11 1/2 | 34            |
| 25-220-36        | 12     | 36            |

**Dilating bougies**  
 Dilatationsbougies  
 Bujías dilatadoras  
 Bougies dilatatrices  
 Candelette dilatatrici

| 15 cm, 6" | Ø mm  | Chr. (French) | 25 cm, 10" |
|-----------|-------|---------------|------------|
| 25-224-08 | 2 1/2 | 8             | 25-225-08  |
| 25-224-10 | 3 1/2 | 10            | 25-225-10  |
| 25-224-12 | 4     | 12            | 25-225-12  |
| 25-224-14 | 4 1/2 | 14            | 25-225-14  |
| 25-224-16 | 5 1/2 | 16            | 25-225-16  |
| 25-224-18 | 6     | 18            | 25-225-18  |
| 25-224-20 | 6 1/2 | 20            | 25-225-20  |

**Metal Catheters for men**

Metallkatheter für männer  
 Sondas metálicas para hombres  
 Sondes vésicales métalliques pour hommes  
 Cateteri metallici per uomini

**Metal Catheters for women**

Metallkatheter für frauen  
 Sondas metálicas para mujeres  
 Sondes vésicales métalliques pour femmes  
 Cateteri metallici per donne

25-228-26  
 26 1/2 cm, 10 1/2"

**Secretion curette malleable**

Sekretlöffel, biegsam  
 Cucharilla para secreción, maleable  
 Cuillère pour prélèvements des secrétions, malléables  
 Curetta per secrezioni, malleabile

**FILIFORM**  
 25-230-12



**GUYON**  
 25-234-00  
 420 x 175 x 40mm

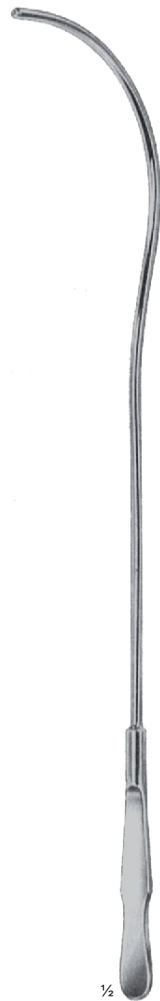

**GUYON**  
 25-234-10  
 25-234-30  
 Chr, French  
 No, 10-30



**GUYON**  
 25-236-39  
 39 cm, 15½"

**Catheter introducing instrument**

Katheter-Einführungsinstrument

Instrumento para introducir catéteres

Mandrin pour sondes en gomme

Stumento per introdurre catetari o sonde



**GUYON**  
 25-238-35  
 35 cm, 13¾"

**Catheter guide (introducer)**

Katheterspanner und Einführungsinstrument

Guía para catéteres (introducer)

Mandrin pour sondes

Catetere guida (Interoduttore)



**25-244-14**  
 14,5 cm, 5¾"

**Fixation clamp for the spermatic cord**

Klemme zum fixieren des Samenstrangs

Piza para fijar el cordón espermático

Pince pour fixer le cordon

Pinza per fissare il tronco spermatico



**Genito-Urinary Instruments**  
 Urologie-Instrumente  
 Instrumentos para la urología  
 Instruments pour l'urologie  
 Strumenti per l'urologia



025

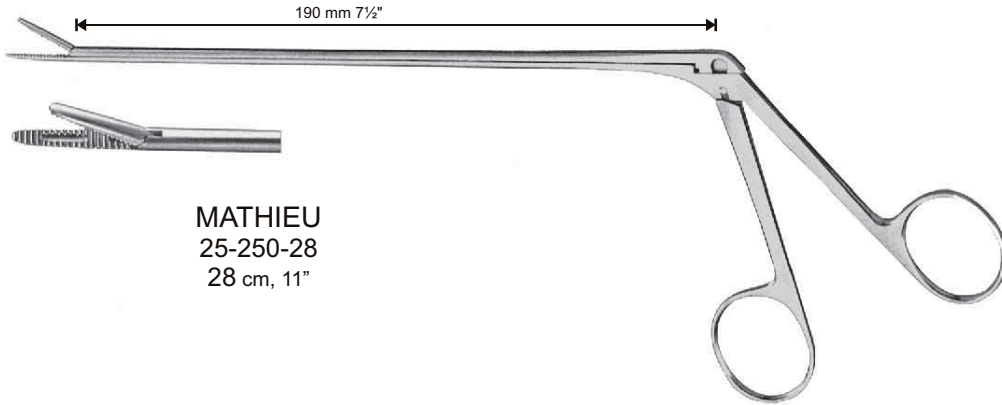

**MATHIEU**  
 25-250-28  
 28 cm, 11"

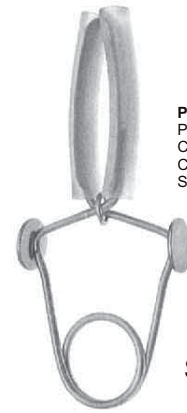

**Penis clamp**  
 Penisklemme  
 Compresor urétral  
 Compresseur de l'urètre  
 Serrapene

**STRAUSS**  
 25-255-11  
 11 cm, 4 3/4"

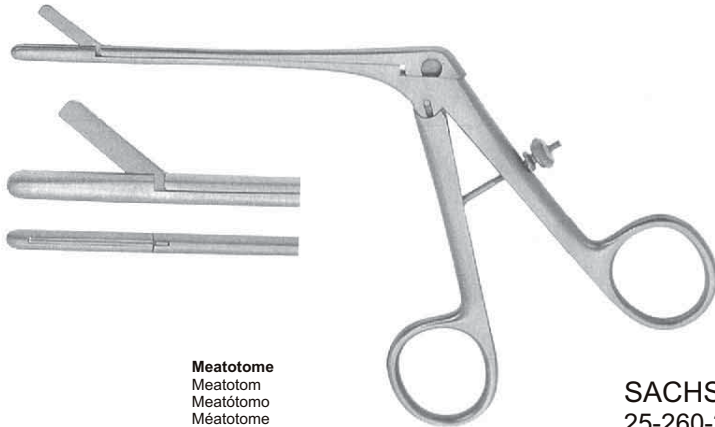

**Meatotome**  
 Meatotom  
 Meatótomo  
 Méatotome  
 Meatotomo

**SACHSE**  
 25-260-20  
 20 cm, 8"

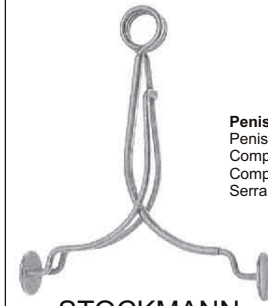

**Penis clamp**  
 Penisklemme  
 Compresor urétral  
 Compresseur de l'urètre  
 Serrapene

**STOCKMANN**  
 25-265-08  
 8 cm, 3 1/4"

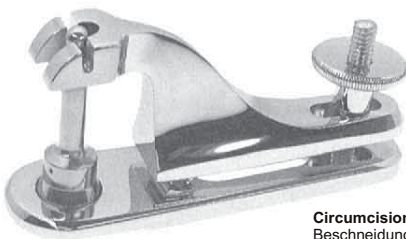

**Circumcision instruments**  
 Beschneidungs- (Circumcisions-) Instrumente  
 Instrumento para circuncisión  
 Instrument de circoncision  
 Strumento per circoncisione

25-270-08 ø8mm  
 baby size, für Säuglinge, para bebés, pour bébés, per neonati

25-270-11 ø11mm  
 25-270-13 ø13mm  
 child size, für Knaben, para niños, pour garçons, per bambini

25-270-16 ø16mm  
 25-270-21 ø21mm  
 adolescent size, für jugendliche, para adolescentes, pour adolescents, per adolescent

25-270-26 ø26mm  
 25-270-32 ø32mm  
 men,s size, für Männer, para hombres, pour hommes, per uomini



**MOGEN**  
 25-272-07  
 7,5 cm, 3"

**Circumcision instrument**  
 Beschneidungs- (Circumcisions-) Instrument  
 Instrumento para circuncisión  
 Instrument de circoncision  
 Strumento per circoncisione



